



Radijator

INŽENJERING



SERVISNA KNJIGA REZERVNIH DELOVA ETAŽ C25.1

ETAŽ C25.1

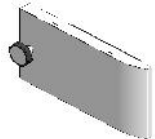



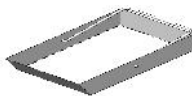

No.	Slika dela / pictures of parts	NAZIV / NAME	Tip kamina / Type of	Dimenzija / Dimesion	CODE PDM	CODE INFOerp	Koli ina	Težina / Weight	
1		Sklop gornjih vrata Etaž C25.1	Etaž C25.1	400x217x122	S0004490		1	8	

2		Sklop donjih vrata Etaž C25.1 - Levi	Etaž C25.1	400x280x122	S0004492		1	10.00	
3		Bo na leva strana oplata Etaž C25.1	Etaž C25.1	732x556x50	D0018923		1	3.30	
4		Sklop me uvratnika Etaž C25.1	Etaž C25.1	400x162x60	S0004646		1	1.00	
5		Fioka Etaž C25.1	Etaž C25.1	473x280x550	S0004493		1	5.00	
6		Plotna Etaž C25.1	Etaž C25.1	1110x580x90	S0004813		1	47.00	
7		Bo na desna strana oplata Etaž C25.1	Etaž C25.1	732x556x50	D0019562		1	3.30	
8		Sklop gornje lajsne Etaž C25.1	Etaž C25.1	995x52x40	S0004776		1	1.30	

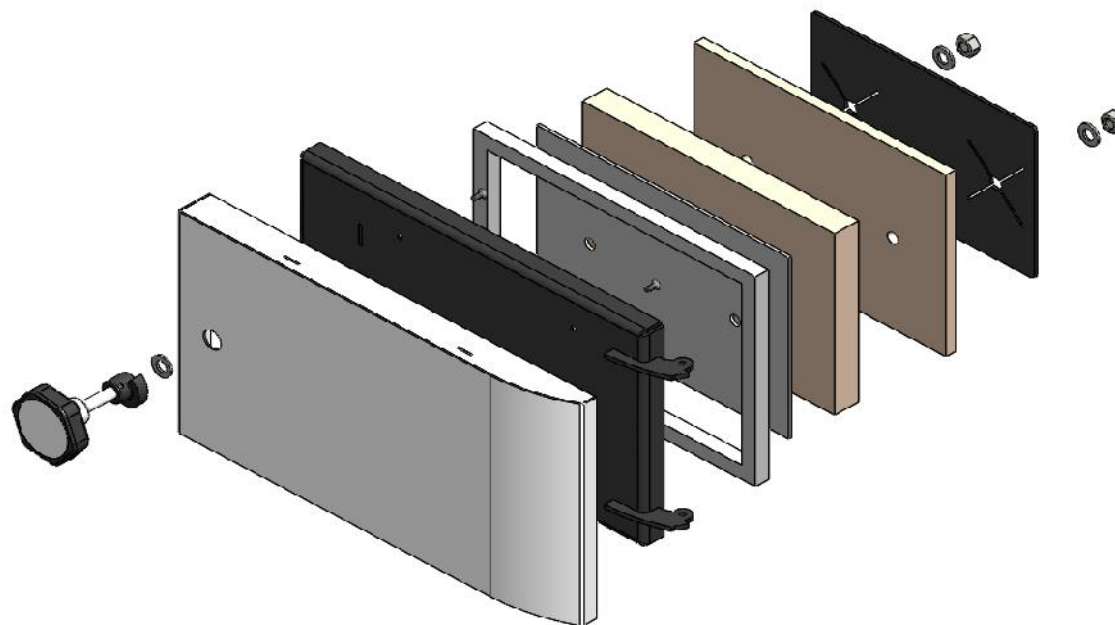
9		Sklop pepeljare Etaž C25.1	Etaž C25.1	460x250x55	S0004726		1	1.40	
10		Vrata rerne - Etaž C25.1	Etaž C25.1	583x381x130	S0004882		1	6.50	
11		Sklop maske regulatora promaje Etaž C25.1	Etaž C25.1	280x107,5x60	S0005697		1	0.50	

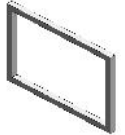
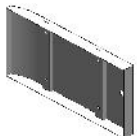
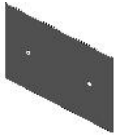
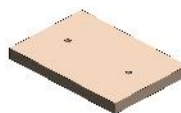
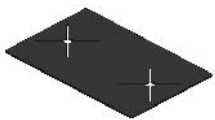

Gornja Vrata ETAŽA C25.1 / Upper Door of ETAZ C25.1

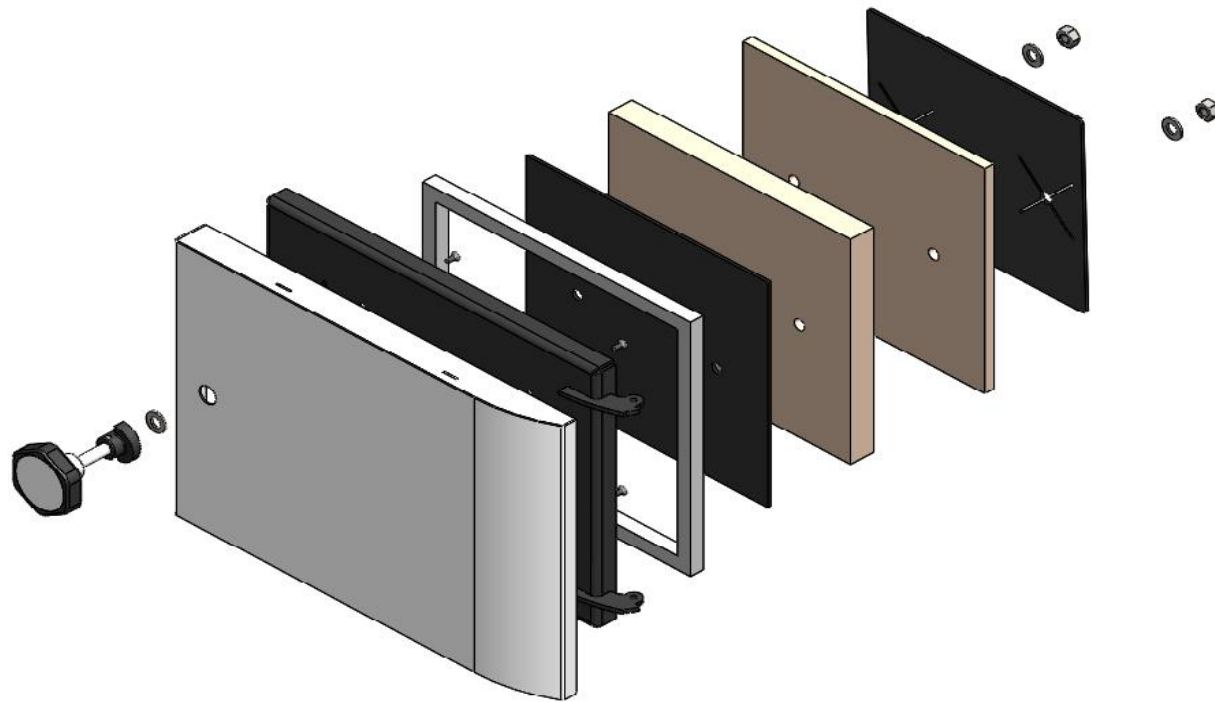

No.	Slika dela / pictures of parts	NAZIV / NAME	Tip kamina / Type of	Dimenzija / Dimesion	CODE PDM	CODE INFOerp	Koli ina	Težina / Weight	
1		Sklop osnovnog lima gornjih vrata Etaž C25.1	Etaž C25.1	390x212x85	S0004638		1	2.50	
2		Pletenica gornjih vrata Etaž C25.1	Etaž C25.1	14x14x950	D0018926		1	0.20	
3		Oplata gornjih vrata Etaž C25.1	Etaž C25.1	400x217x35	S0004636		1	1.70	
4		Kerami ki karton gornjih vrata Etaž C25.1	Etaž C25.1	260x178x3	D0018976		1	0.15	
5		Izolacija gornjih vrata Etaž C25.1 - vermikulit	Etaž C25.1	260x178x25	D0018977		2	1.10	
6		Ploca izolacije gornjih vrata Etaž C25.1	Etaž C25.1	230x148x3	D0018978		1	1.00	
7		Rucica za etaz 25 - komplet	Etaž C25.1	60x90	K0001682		1	0.6	
<i>Donja Vrata ETAŽA C25.1 / Lower Door of ETAZ C25.1</i>									

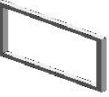
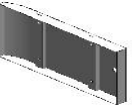

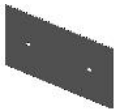
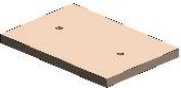
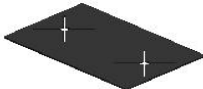

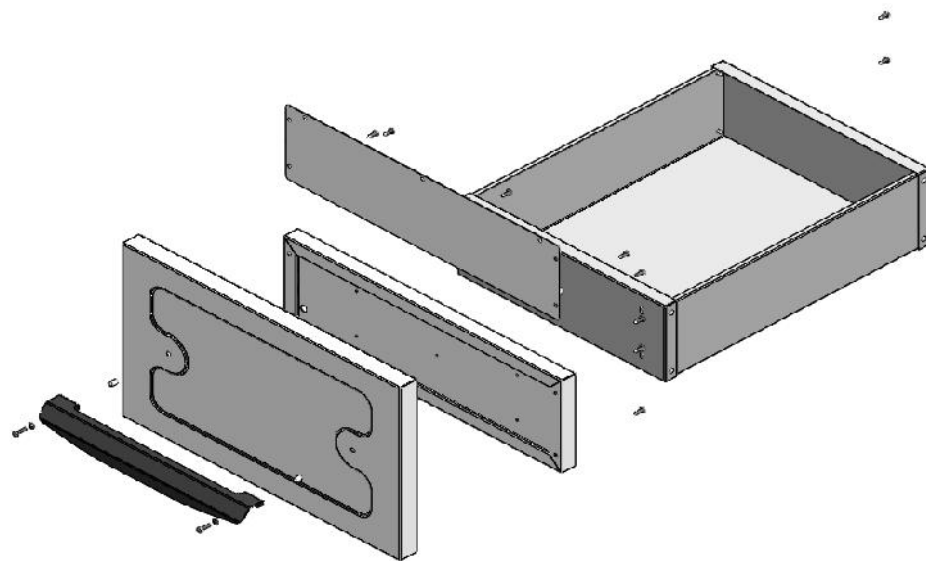

No.	Slika dela / pictures of parts	NAZIV / NAME	Tip kamina / Type of	Dimenzija / Dimesion	CODE PDM	CODE INFOerp	Koli ina	Težina / Weight	
1		Sklop osnovnog lima donjih vrata Etaž C25.1 - Levi	Etaž C25.1	390x266x85	S0004640		1	3.00	
2		Pletenica donjih vrata Etaž C25.1	Etaž C25.1	14x14x1050	D0018936		1	0.25	
3		Oplata donjih vrata Etaž C25.1 - Levi	Etaž C25.1	400x280x35	S0004639		1	2.50	

4		Kerami ki karton donjih vrata Etaž C25.1	Etaž C25.1	260x230x3	D0018951		1	0.20	
5		Izolacija donjih vrata - vermikulit Etaž C25.1	Etaž C25.1	260x230x25	D0018953		2	2.70	
6		Ploca izolacije donjih vrata Etaž C25.1	Etaž C25.1	230x194x3	D0018982		1	1.20	
7		Rucica za etaz 25 - komplet	Etaž C25.1	60x90	K0001682		1	0.6	

Fijoka ETAŽA C25.1



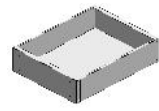
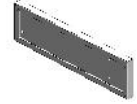

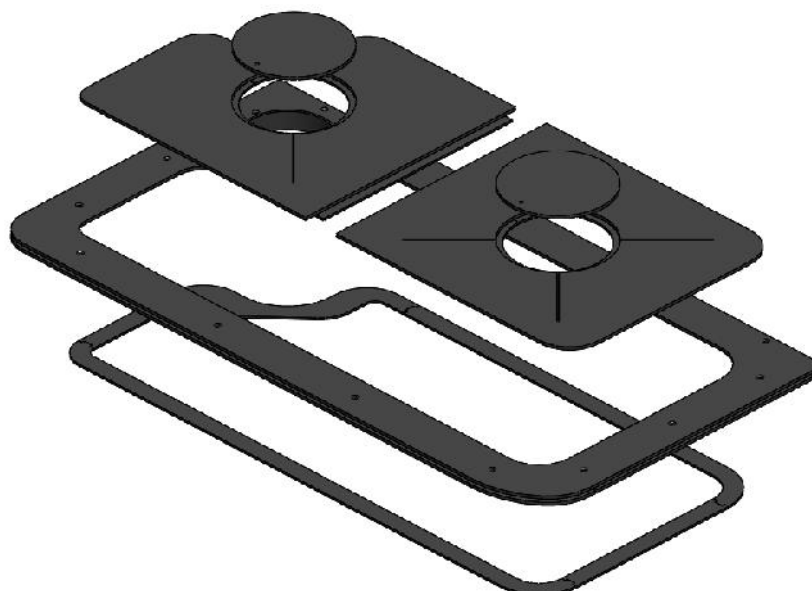

No.	Slika dela / pictures of parts	NAZIV / NAME	Tip kamina / Type of	Dimenzija / Dimension	CODE PDM	CODE INFOerp	Koli ina	Težina / Weight	
-----	--------------------------------	--------------	----------------------	-----------------------	----------	--------------	----------	-----------------	--

1		Poklopac fioke šporeta Etaž C25.1	Etaž C25.1	473x280x30	D0018969		1	1.30	
2		Ru ica fioke Etaž C25,1	Etaž C25.1	345x80x1,5	D0020747		1	0.40	
3		Sklop zadnje strane fioke Etaž C25.1	Etaž C25.1	352x451x125	S0004777		1	2.50	
4		Unutrašnji lim fioke	Etaž C25.1	473x150x25	D0029165		1	0.80	
5		Gornji lim fioke Etaž C25.1	Etaž C25.1	465x120x0,8	D0029167		1	0.40	



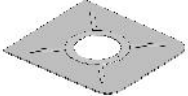

Plotna ETAŽA C25.1



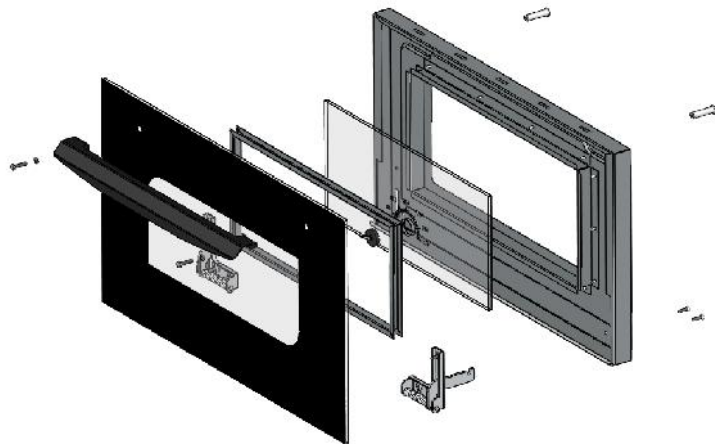

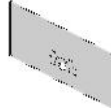

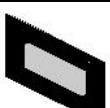
No.	Slika dela / pictures of parts	NAZIV / NAME	Tip kamina / Type of	Dimenzija / Dimesion	CODE PDM	CODE INFOerp	Koli ina	Težina / Weight
1		Sklop okvira plotne Etaž C25,1	Etaž C25.1	1110x580x45	S0004817		1	24.00
2		Plotna leva Etaž C25.1	Etaž C25.1	490x430x10	S0004983		1	8.30
3		Plotna desna Etaž C25.1	Etaž C25.1	478x429x10	S0004816		1	9.20
4		Ringla Etaž C25.1	Etaž C25.1	179x179x6	D0021374		2	1.20
5		Sklop nosa a plotne	Etaž C25.1	1110x580x45	S0004833		1	2.70

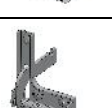
Vrata rene ETAŽA C25.1

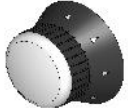

No.	Slika dela / pictures of parts	NAZIV / NAME	Tip kamina / Type of	Dimenzija / Dimesion	CODE PDM	CODE INFOerp	Koli ina	Težina / Weight	
1		Sklop osnovnog lima vrata rerne Etaž C25.1	Etaž C25.1	580x360x40	S0004808		1	1.80	
2		Staklo za sporet - unutrašnje	Etaž C25.1	393x193x5	K0000516		1	1.00	
3		Sklop drzaca stakla	Etaž C25.1	395x195x20	S0004716		1	0.30	
4		Termometar rerne Etaž C25	Etaž C25.1	fi 27	K0001420		1	0.10	
5		Staklo rerne - Etaž C25.1	Etaž C25.1	583x381	K0000515		1	3.00	
6		Ru ica rerne Etaž C25,1	Etaž C25.1	435x80x1,5	D0020887		1	0.40	
7		Sarka za sporet - leva	Etaž C25.1	100x80x80	K0000431		1	0.10	
8		Sarka za sporet - leva	Etaž C25.1	100x80x80	K0000430		1	0.10	

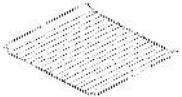
Ostalo ETAŽA C25.1

No.	Slika dela / pictures of parts	NAZIV / NAME	Tip kamina / Type of	Dimenzija / Dimesion	CODE PDM	CODE INFOerp	Koli ina	Težina / Weight	
1		Dugme regulatora promaje	Etaž C25.1	61,5x41,5	/		1		
2		Regulator promaje Etaž C25	Etaž C25.1		K0001422		1	0.30	
3		Sklop rerne Etaž C25.1	Etaž C25.1		S0004698		1	6.00	
4		Rešetka rerne Etaž C25.1	Etaž C25.1		K0001655		1	0.70	
5		Rešetka Etaž C25.1 - Levi	Etaž C25.1		D0020865		1	1.30	
6		Rost sporeta C-25	Etaž C25.1		K0000428		3	3.60	