

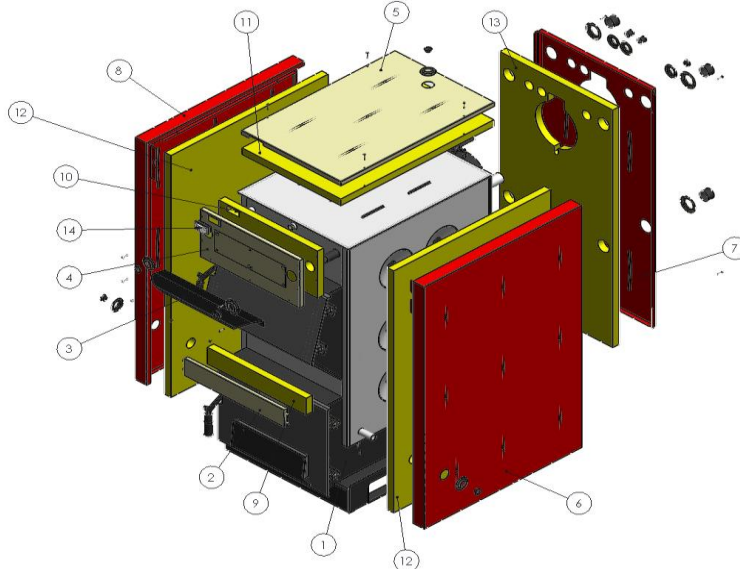













 Spisak rezervnih delova za kotlove C 15; C 25; C 33; C 40; C 50 /  
 List of spare parts for C 15; C 25; C 33; C 40; C 50

**KOTAO SA OPLATOM C SERIJA**

No.	Slika dela / pictures of parts	Naziv / Name	Tip kotla / Type of boiler	Dimenzija / Dimesion	CODE PDM	CODE INFOerp	Q.	Težina / Weight (kg)	
1		Telo kotla sa ložištem	C 15	746x394x1093	SW-8348		1	145,00	
			C 25	824x486x1174	SW-3988		1	238,00	
			C 33	900x594x1192	SW-7281		1	308,00	
			C 40	900x644x1192	SW-7962		1	325,00	
			C 50	906x708x1308	SW-7701		1	381,00	
2		Sklop međuvratnika oplate	C 15	300x80x15	S0002546		1	0,20	
			C 25	407x100x20	S0002560		1	0,37	
			C 33	505x80x15	S0000651		1	0,36	
			C 40	554x78x15	S0000597		1	0,38	
			C 50	554x76x15	S0000573		1	0,38	
3		Štitnik oplate	C 15	267x166x50	SW-8419		1	0,26	
			C 25	364x166x46	SW-8576		1	0,35	
			C 33	473x164x45	SW-7353		1	0,46	
			C 40						
			C 50	523x166x46	SW-7793		1	0,53	
4		Čeona strana oplate	C 15	304x241x20	SW-8347		1	0,42	
			C 25	337x220x20	S0002557		1	0,81	
			C 33	476x220x20	S0000653		1	1,05	
			C 40	524x219x20	S0000594		1	1,13	
			C 50	525x317x18	S0000572		1	1,46	
5		Sklop krova oplate	C 15	575x217x20	S0002552		1	1,20	
			C 25	677x377x20	S0002558		1	1,80	
			C 33	735x476x20	S0000649		1	2,55	
			C 40	524x734x20	S0000593		1	2,80	
			C 50	749x525x19	S0000570		1	2,80	
6		Sklop bočne desne strane oplate	C 15	595x1015x83	S0002548		1	4,90	
			C 25	1119x687x80	S0002556		1	6,00	
			C 33	1119x755x84	S0000560		1	6,62	
			C 40						
			C 50	1230x767x116	S0000567		1	7,70	
7		Sklop zadnje strane oplate	C 15	995x375x18	S0002551		1	2,50	
			C 25	1098x470x15	S0002559		1	3,30	
			C 33	1098x578x20	S0000650		1	4,10	
			C 40	1099x628x18	S0000562		1	4,42	
			C 50	1210x693x19	S0000569		1	5,34	
8		Sklop bočne leve strane oplate	C 15	83x595x1015	S0002549		1	4,90	
			C 25	1119x687x80	S0002555		1	6,00	
			C 33	1119x755x84	S0000561		1	4,10	
			C 40						
			C 50	1230x767x116	S0000568		1	7,70	

9		Izolacija međuvratnika oplate	C 15	267x76x30	SW-8418		1	0,03
			C 25	373x96x30	SW-4012		1	0,05
			C 33	472x76x30	D0002589		1	0,05
			C 40	519x76x30	SW-7975		1	0,06
			C 50	521x72x30	SW-7804		1	0,05
10		Izolacija čelone strane oplate	C 15	267x192x30	SW-8417		1	0,07
			C 25	373x216x30	SW-4011		1	0,11
			C 33	472x217x30	D0002588		1	0,15
			C 40	521x216x30	SW-7974		1	0,16
			C 50	521x313x30	SW-7803		1	0,23
11		Izolacija krova oplate	C 15	571x267x30	SW-8416		1	0,23
			C 25	664x373x30	SW-4010		1	0,37
			C 33	731x472x30	D0002587		1	0,51
			C 40	731x521x30	SW-7973		1	0,57
			C 50	748x522x30	SW-7802		1	0,58
12		Izolacija bočne strane oplate	C 15	1012x591x30	SW-8414		2	0,90
			C 25	1115x683x30	SW-4008		2	1,14
			C 33	1115x751x30	SW-7363		2	1,25
			C 40	1226x763x30	SW-7800		2	1,40
			C 50	1226x763x30	SW-7800		2	1,40
13		Izolacija zadnje strane	C 15	991x337x30	SW-8415		1	0,45
			C 25	1094x433x30	SW-4009		1	0,65
			C 33	1095x540x30	D0002586		1	0,81
			C 40	1097x594x30	SW-7972		1	0,90
			C 50	1206x655x30	SW-7801		1	1,10
14		Termometar za etaž	C 15					
			C 25					
			C 33		K0000752		1	0,30
			C 40					
			C 50					

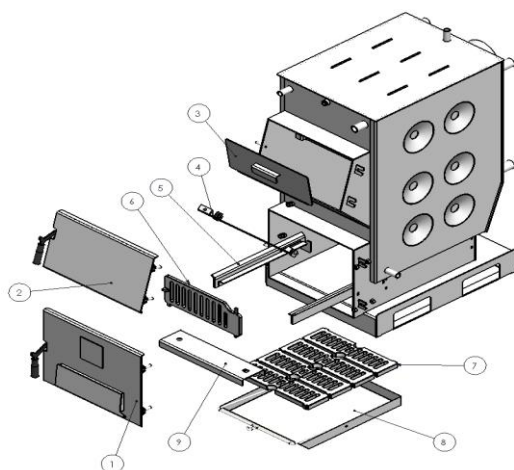
SKLOP KOTLA C 15; C 25; C 33; C 40; C 50



No.	Slika dela / pictures of parts	Naziv / Name	Tip kotla / Type of boiler	Dimenzija / Dimesion	CODE PDM	CODE INFOerp	Q.	Težna / Weight (kg)
1		Donja vrata	C 15	404x323x110	SW-8359		1	9,34
			C 25	404x415x110	SW-3960		1	11,2
			C 33	523x403x110	SW-7219		1	13,7
			C 40	552x403x110	SW-7615		1	14,7
			C 50					
2		Gornja vrata	C 15	320x283x110	SW-8360		1	6,4
			C 25	411x290x110	SW-3982		1	8,16
			C 33	520x286x110	SW-7240		1	10,3
			C 40	570x286x110	SW-7624		1	11,13
			C 50					
3		Sklop klapne	C 15	240x196x41	SW-8392		1	1,6
			C 25	332x196x41	SW-3996		1	2,26
			C 33	440x198x42	SW-7269		1	2,96
			C 40	480x196x42	SW-7970		1	3,3
			C 50	540x254x29	SW-7627		1	4,85
4		Sklop klapne gornjeg okvira	C 15	235x170x24	SW-8388		1	1,14
			C 25	330x165x29	SW-8561		1	1,63
			C 33	435x165x27	SW-8635		1	2,18
			C 40	485x165x29	SW-7635		1	2,446
			C 50					
5		Sklop nosača rosta	C 15	/	/		/	/
			C 25	368x60x38	S0002554		2	2
			C 33	481x68x59	S0000634		2	2,9
			C 40	480x73x70	S0000551		2	3,4
			C 50	/	/		/	/
6		Rešetka	C 15	230x150x10	SW-8406		1	1,8
			C 25	293x183x34	K0000775		1	3,8
			C 33	400x150x14	K0000754		1	5
			C 40					
			C 50					
7		Rost	C 15	280x117x25	K0000273		2	4,3
			C 25				3	
			C 33	400x120x25	K0000753		4	5,6
			C 40	538x126x30	K0000250		4	9,56
			C 50	460x230x51	SW-8398		1	1,3
8		Sklop pepeljare	C 25	460x321x50	S0002568		1	1,67
			C 33	543x430x50	SW-7280		1	2,87
			C 40	535x480x50	SW-7692		1	3,1
			C 50					
			9		Prag	C 15	240x198x35	SW-8393
C 25	336x141x35	SW-3990					1	1,52
C 33	446x120x35	SW-7273					1	2,47
C 40	495x120x35	SW-7965					1	2,76
C 50	495x80x25	SW-7638					1	1,8