

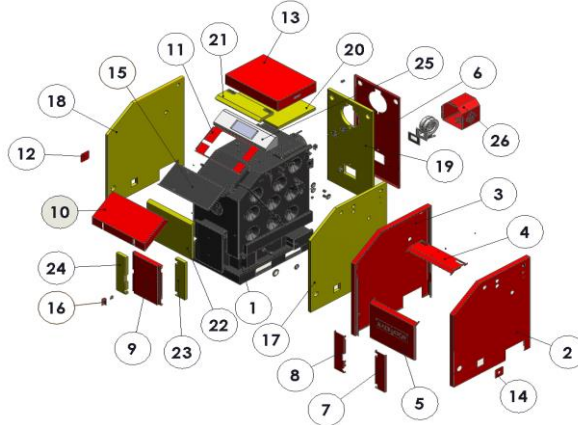













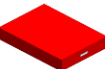





Spisak rezervnih delova za kotlove FK 1.1 ; FK 2.1; FK 3.1; FK 4.1 / List of spare parts for FK 1.1 ; FK 2.1; FK 3.1; FK 4.1



KOTAO SA OPLATOM FK

No.	Naziv / Name	Slika dela / Pictures of parts	Tip kotla / Type of boiler	Dimenzija / Dimension	CODE PDM	CODE INFOerp	Q.	Težina / Weight (kg)
1	Telo kotla/ Body of boiler		FK 1.1	974x540x1040	S0003092		1	241,00
			FK 2.1	1105x580x1135	S0003153			324,90
			FK 3.1	1170x640x1190	S0003168			372,50
			FK 4.1	1139x730x1245	S0003282			417,50
2	Lim bočne desne strane oplate/ Right side hand panel		FK 1.1	800x892x64.2	D0011217		1	5,00
			FK 2.1	900x64.2x990	D0011713			6,30
			FK 3.1	960x64.2x1043.5	D0011762			7,10
			FK 4.1	960x64.2x1093.5	D0012206			7,60
3	Lim bočne leve strane oplate/ Left side hand panel		FK 1.1	800x892x64.2	D0011218		1	5,00
			FK 2.1	900x64.2x990	D0011714			6,30
			FK 3.1	960x64.2x1043.5	D0011763			7,15
			FK 4.1	960x64.2x1093.5	D0012207			7,60
4	Lim gornje kosine oplate/ Slope panel- Upper		FK 1.1	372x150x50	D0011219		1	0,34
			FK 2.1	420x12x50	D0012309			0,60
			FK 3.1	230x470x50	D0012332			0,69
			FK 4.1	220x560x50	D0012211			0,80
5	Sklop prednje kosine oplate/ Slope panel - front		FK 1.1	372x70x255	S0003098		1	1,60
			FK 2.1	420x70x350	S0003158			2,36
			FK 3.1	470x60x400	S0003216			2,87
			FK 4.1	560x60x440	S0003297			3,80
6	Lim zadnje strane oplate/ Back panel		FK 1.1	372x20x892	D0011221		1	2,04
			FK 2.1	420x20x990	D0012310			2,55
			FK 3.1	470x20x1043.5	D0012333			3,00
			FK 4.1	560x20x1093.5	D0012212			3,80
7	U profil oplate desni/ U profile right		FK 1.1	30.8x20x446.5	D0011629		1	0,16
			FK 2.1	62.5x20x446.5	D0011806			0,25
			FK 3.1	82.5x20x446.5	D0011838			0,30
			FK 4.1	122.5x20x446.5	D0012209			0,42
8	U profil oplate levi/ U profile left		FK 1.1	30.8x20x446.5	D0036020		1	0,15
			FK 2.1	62.5x20x446.5	D0011806			0,25
			FK 3.1	82.5x20x446.5	D0011839			3,00
			FK 4.1	122.5x20x446.5	D0012210			0,42
9	Lim maske donjih vrata oplate/ Mask of lower door		FK 1.1	360x48x470.6	D0011585		1	1,41
			FK 2.1					
			FK 3.1					
			FK 4.1					

10	Poklopac gornjih vrata/ Cover upper door		FK 1.1	472x78x365	D0011224	1	3,10
			FK 2.1	520x78x365	D0012315		3,37
			FK 3.1	365x78x570	D0012335		3,65
			FK 4.1	660x365x78	D0012237		4,30
11	Unutrasnji kosi deo oplate / Inside part of slope panel		FK 1.1	372x319.5x20	D0011223	1	0,34
			FK 2.1	420x310x20	D0012317		0,33
			FK 3.1	470x310x20	D0012336		0,39
			FK 4.1	560x310x20	D0012214		0,56
12	Poklopac otvora za cesalj stepi / The cover of the comb-blind		FK 1.1	100x100x0.8	D0029164	1	0,06
			FK 2.1				
			FK 3.1				
			FK 4.1				
13	Sklop krova oplate / Assembly of top panel		FK 1.1	472x345x65	D0011222	1	1,81
			FK 2.1	420x520x120	S0005461		2,97
			FK 3.1	570x480x120	S0005475		3,52
			FK 4.1	660x480x120	S0005482		3,95
14	Poklopac otvora za cesalj / The cover of the comb		FK 1.1	100x100x0.8	D0029160	1	0,06
			FK 2.1				
			FK 3.1				
			FK 4.1				
15	Usmerivac oplate gornjih vrata /		FK 1.1	462x270x40	D0011719	1	3,32
			FK 2.1	512x270x40	SW-5255		3,66
			FK 3.1	562x40x270	SW-8060		4,16
			FK 4.1	622x40x270	SW-8494		4,60
16	Sklop donjeg granicnika mikroprekidaca / The lower set of stop microswitch		FK 1.1	25.2x30x80	S0006570	1	0,06
			FK 2.1				
			FK 3.1				
			FK 4.1				
17	Izolacija bočne desne strane oplate / Insolation of right side panel		FK 1.1	888.4x796.4x30	D0011232	1	0,93
			FK 2.1	896.4x30x986.4	D0011696		1,20
			FK 3.1	956.4x30x1040	D0011824		1,36
			FK 4.1	957x30x1090	D0012223		1,44
18	Izolacija bočne leve strane oplate / Insolation of left side panel		FK 1.1	888.4x796.4x30	D0011229	1	0,93
			FK 2.1	896.4x30x986.4	D0011699		1,20
			FK 3.1	956.4x30x1040	D0011825		1,37
			FK 4.1	957x30x1090	D0012219		1,44
19	Izolacija zadnje strane oplate / Insolation of back panel		FK 1.1	888.4x346.4x30	D0011230	1	0,38
			FK 2.1	416.4x30x986.4	D0011700		0,53
			FK 3.1	466.4x30x1040	SW-8120		0,62
			FK 4.1	557x30x1090	SW-8699		0,81
20	Izolacija krova oplate / Insolation of top panel		FK 1.1	341.3x446.4x30	D0011231	1	0,23
			FK 2.1	516.4x411.4x30	D0011709		0,32
			FK 3.1	471x30x566	SW-8121		0,40
			FK 4.1	472x30x657	SW-8698		0,46
21	Izolacija gornje kosine oplate / Insulation upper slope panel		FK 1.1	368.4x108.3x41.5	D0015553	1	0,05
			FK 2.1	418x180x46	D0011710		0,10
			FK 3.1	468.4x185.4x42	SW-18619		0,08
			FK 4.1	559x49x182	SW-21165		0,14
22	Izolacija prednje donje kosine oplate / Insolation of front lower slope panel		FK 1.1	368.5x237.5x55	D0011227	1	0,14
			FK 2.1	417x337x55	D0011702		0,22
			FK 3.1	467x168.8x42	SW-18618		0,08
			FK 4.1	557x30x440	D0012227		0,37
23	Izolacija prednje leve strane oplate / Insolation of front left side panel		FK 1.1	/	/	/	/
			FK 2.1				
			FK 3.1				
			FK 4.1				
24	Izolacija prednje desne strane oplate / Insolation of front right side panel		FK 1.1	/	/	/	/
			FK 2.1				
			FK 3.1				
			FK 4.1				
25	Kuciste automatike / Control panel		FK 1.1	472x125x160	S0003149	1	2,20
			FK 2.1	520x150x120	S0005460		2,05
			FK 3.1	570x150x120	S0005471		2,27
			FK 4.1	660x150x120	S0005481		2,54
26	Poklopac zadnjeg ventilatora / Fan cover		FK 1.1	230x275x264	S0003298	1	1,70
			FK 2.1				
			FK 3.1				
			FK 4.1				

SKLOP KOTLA FK1.1; FK2.1; FK3.1; FK4.1

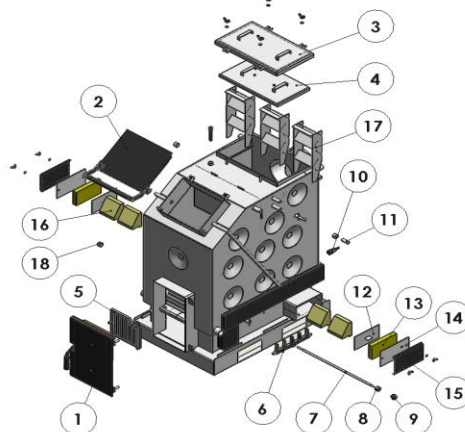







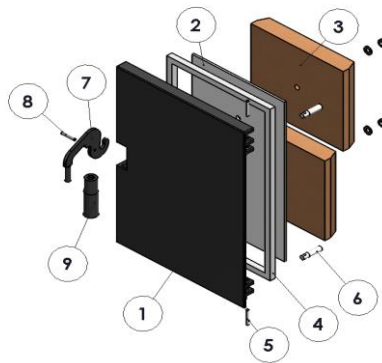

No.	Naziv / Name	Slika dela / Pictures of parts	Tip kotla / Type of boiler	Dimenzija / Dimension	CODE PDM	CODE INFOerp	Q.	Težina / Weight (kg)
1	Sklop donjih vrata / Assembly lower door		FK 1.1	350x121x462	S0003210		1	22,50
			FK 2.1					
			FK 3.1					
			FK 4.1					
2	Livena gornja vrata / Cast upper door		FK 1.1	462x106x415	S0003151		1	15,65
			FK 2.1	400x250x410	S0001614			20,90
			FK 3.1					
			FK 4.1					
3	Gornja vrata za ciscenje / Upper door for cleaning		FK 1.1	315x64x428	SW-17987		1	6,74
			FK 2.1	387x64x400	SW-4994			8,27
			FK 3.1	387x64x460	SW-8025			9,37
			FK 4.1	387x64x518	SW-8459			10,40
4	Cance gornjeg otvora za ciscenje / The cover for the upper opening for cleaning		FK 1.1	314x241,5x55	SW-7123		1	4,00
			FK 2.1	363x274x55	SW-6167			5,00
			FK 3.1	424x275x65	SW-8037			5,90
			FK 4.1	484x275x65	SW-8468			6,70
5	Mala resetka / Small grid		FK 1.1	240x215x34	K0000143		1	3,90
			FK 2.1					
			FK 3.1					
			FK 4.1					
6	Cesalji za ciscenje / Comb for cleaning		FK 1.1	315x30x80	D0010192		1	1,50
			FK 2.1					
			FK 3.1					
			FK 4.1					
7	Sipka za cesalji / Rod for comb		FK 1.1	Ø12x450	D0010348		1	0,38
			FK 2.1	Ø12x500	D0010193			0,42
			FK 3.1	Ø12x560	D0010248			0,48
			FK 4.1	Ø12x635	D0010383			0,55
8	Sklop dichtung klapne / Assembly for sealing flap		FK 1.1	Ø30x20	S0000714		3	0,06
			FK 2.1					
			FK 3.1					
			FK 4.1					
9	Kuglica F 35 sa unutrašnjim navojem M 10		FK 1.1	Ø35	K0001463		1	0,02
			FK 2.1					
			FK 3.1					
			FK 4.1					
10	Plastična ručica sa umetkom / Plastic handle		FK 1.1	Ø30x90	K0000142		1	0,00
			FK 2.1					
			FK 3.1					
			FK 4.1					
11	Sipka - caura osovine klapne		FK 1.1	Ø20x50	SW-3694		1	0,09
			FK 2.1					
			FK 3.1					
			FK 4.1					
12	Unutrasnji poklopac za ciscenje manji / The inner cover cleaning - smaller		FK 1.1	105x205x33	SW-4313		2	0,54
			FK 2.1					
			FK 3.1					
			FK 4.1					

13	Tervol poklopca za ciscenje manji / Insolatorin of cover cleaning		FK 1.1	105x205x30	SW-4312		2	0,03	
			FK 2.1						
			FK 3.1						
			FK 4.1						
14	Izolacija bočnih otvora za ciscenje / Insolator of lateral openings for cleaning		FK 1.1	238x5x120	SW-4292		2	0,14	
			FK 2.1						
			FK 3.1						
			FK 4.1						
15	Bočni poklopac otvora za ciscenje / Side cover hole for cleaning		FK 1.1	238x18x136	SW-4240		2	1,19	
			FK 2.1						
			FK 3.1						
			FK 4.1						
16	Vatrostalna opeka 120 mm / Bricks 120 mm		FK 1.1	100x110x80	K0000226		3	1,43	
			FK 2.1	120x110x80	K0000144			1,72	
			FK 3.1	100x110x80	K0000226			4	1,43
			FK 4.1	120x110x80	K0000144				1,72
17	Turbulator / Turbulator		FK 1.1	300x102x82	SW-14107		3	1,60	
			FK 2.1	380x120x93	SW-14101			2,26	
			FK 3.1	380x139x93	SW-14197			2,42	
			FK 4.1	380x159x78	SW-14188			2,62	
18	Sklop dichtung klapne / Assembly for sealing flap		FK 1.1	Ø30x20	S0002947		1	0,06	
			FK 2.1						
			FK 3.1						
			FK 4.1						

SKLOP DONJIH VRATA ZA KOTLOVE: FK1.1; FK2.1; FK3.1; FK4.1









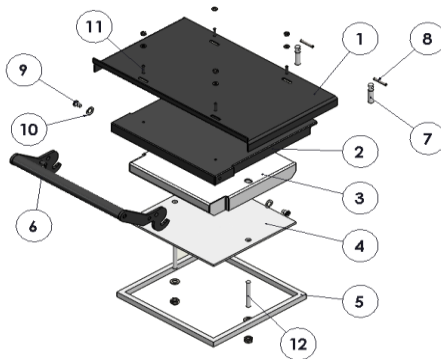





No.	Naziv / Name	Slika dela / Pictures of parts	Tip kotla / Type of boiler	Dimenzija / Dimension	CODE PDM	CODE INFOerp	Q.	Težina / Weight (kg)
1	Livena donja vrata / Cast lower door		FK 1.1	462x27x350	D0011803		1	11,40
			FK 2.1					
			FK 3.1					
			FK 4.1					
2	Izolacioni karton vrata / Insulation cardboard for door		FK 1.1	418.5x5x252	D0008638		1	0,50
			FK 2.1					
			FK 3.1					
			FK 4.1					
3	Vatrostalna opeka donjih vrata / Cast lower door		FK 1.1	252x209x40	K0000254		2	4,90
			FK 2.1					
			FK 3.1					
			FK 4.1					
4	Pletenica vrata / Ceramic rope		FK 1.1	14x14x1464	D0011804		1	0,23
			FK 2.1					
			FK 3.1					
			FK 4.1					
5	Civija Ø6x40 / Bolt		FK 1.1	Ø6x40	K0000025		2	/
			FK 2.1					
			FK 3.1					
			FK 4.1					
6	Brezon sarke vrata / Threaded rod		FK 1.1	Ø12x50	SW-3713		2	0,04
			FK 2.1					
			FK 3.1					
			FK 4.1					
7	Sklop ručice / Handle		FK 1.1	118x105x12	S0003659		1	0,23
			FK 2.1					
			FK 3.1					
			FK 4.1					

8	Civija Ø6x36 / Bolt		FK 1.1	Ø6x36	K0000024		1	0,01
			FK 2.1					
			FK 3.1					
			FK 4.1					
9	Plastična ručica sa umetkom / Plastic handle with insert		FK1.1 - FK4.1	100xØ30	K0000155		1	0,20

LIVENA GORNJA MANJA VRATA ZA FK1.1



No.	Naziv / Name	Slika dela / Pictures of parts	Tip kotla / Type of boiler	Dimenzija / Dimension	CODE PDM	CODE INFOerp	Q.	Težina / Weight (kg)
1	Usmerivač oplate gornjih vrata		FK 1.1	462x270x25	D0011719		1	3,32
2	Livena gornja manja vrata / Cast upper door		FK 1.1	312x312x27	D0011686		1	7,90
3	Cance za beton manjih vrata / Concrete for smaller door		FK 1.1	257x252x38	S0003165		1	2,70
4	Keramicki karton gornjih limenih manjih vrata / Ceramic cardboard for upper door		FK 1.1	259x247x5	D0010594		1	0,30
5	Pletenica gornjih manjih limenih vrata / Ceramic rope		FK 1.1	14x14x1134	D0010596		1	0,15
6	Rucica gornjih vrata / Handle		FK 1.1	330x170x53	SW-18759		1	1,07
7	Brezon sarke vrata / Threaded rod		FK 1.1	Ø12x50	SW-3713		2	0,04
8	Civija Ø6x36 / Bolt		FK 1.1	Ø6x36	K0000024		2	/
9	Nosac rucice D 10 / Carrier handles D 10		FK 1.1	Ø14x15.5	K0000823		2	/
10	Podloska zakrivljena D10		FK 1.1	/	K0000222		2	/
11	Navojna sipka- nosac lima oplate / Threaded rod - Carrier panel		FK 1.1	M6x20	SW-1512		4	/
12	Navojna sipka M10x70 / Threaded rod M10x70		FK 1.1	M10x70	D0011720		2	/



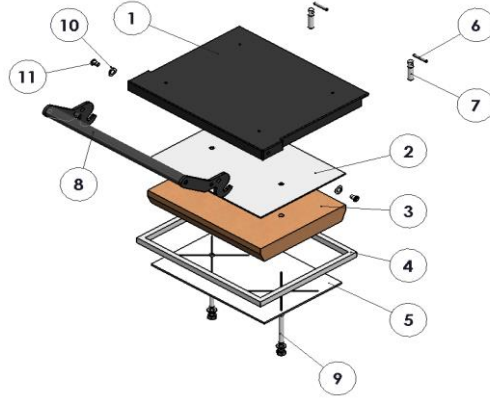















LIVENA GORNJA VRATA ZA FK2.1 ; FK3.1 ; FK 4.1









No.	Naziv / Name	Slika dela / Pictures of parts	Tip kotla / Type of boiler	Dimenzija / Dimesion	CODE PDM	CODE INFOerp	Q.	Težina / Weight (kg)
1	Livena gornja vrata / <i>Cast upper door</i>		FK 2.1	390x315x27		D0005217	1	9,40
			FK 3.1					
2	Keramicki karton vrata / <i>Ceramic cardboard for door</i>		FK 2.1	326x3x245		SW-3734	1	0,23
			FK 3.1					
			FK 4.1					
3	Vatrostalna opeka gornjih vrata / <i>Cast upper door</i>		FK 2.1	326x40x245		K0000255	1	7,43
			FK 3.1					
			FK 4.1					
4	Pletenica gornjih manjih livenih vrata / <i>Ceramic rope</i>		FK 2.1	14x14x1270		SW-4362	1	0,17
			FK 3.1					
			FK 4.1					
5	Ploca izolacije / <i>Panel insulation</i>		FK 2.1	326x224x4		SW-17318	1	2,26
			FK 3.1					
			FK 4.1					
6	Civija Ø6x36 / <i>Bolt</i>		FK 2.1	Ø6x36		K0000024	2	/
			FK 3.1					
			FK 4.1					
7	Brezon sarke vrata / <i>Threaded rod</i>		FK 2.1	Ø12x50		SW-3713	2	0,04
			FK 3.1					
			FK 4.1					
8	Rucice gornjih vrata / <i>The handle upper door</i>		FK 2.1	170x60x399		S0003760	1	1,20
			FK 3.1					
			FK 4.1					
9	Brezon / <i>Threaded rod</i>		FK 2.1	M10x75		D0008647	2	0,05
			FK 3.1					
			FK 4.1					
10	Podloska zakrivljena D10		FK 2.1	/		K0000222	2	/
			FK 3.1					
			FK 4.1					
11	Nosac rucice D 10 / <i>Carrier handles</i>		FK 2.1	Ø14x15.5		K0000823	2	/
			FK 3.1					
			FK 4.1					

ELEKTRO KOMPONENTE I OSTALO ZA FK / Electrical component & other for FK

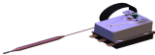
No.	Naziv / Name	Slika dela / Pictures of parts	Tip kotla / Type of boiler	Dimenzija / Dimesion	CODE PDM	CODE INFOerp	Q.	Težina / Weight (kg)
1	Ventilator, WPA120 (R2E120-AR38-40) / <i>Fan, WPA120 (R2E120-AR38-40)</i>		FK 1.1	210x180x160	K0001121		1	5,70
			FK 2.1					
			FK 3.1					
			FK 4.1					

2	Sonda 1/2" x 110 mm ACV 63438001 / Probe 1/2" x 110 mm ACV 63438001		FK 1.1	110x25	K0000349	1	0,03
			FK 2.1				
			FK 3.1				
			FK 4.1				
3	Mikro prekidač / Mikro switch		FK 1.1	46x17x50	D0020617	2	0,06
			FK 2.1				
			FK 3.1				
			FK 4.1				
4	Kablovska uvodnica PG-11 PVC		FK 1.1	36x23	K0000414	1	/
			FK 2.1				
			FK 3.1				
			FK 4.1				
5	Konektor, sedmopolni, muski EP1500 (EP7M+EP7G) / 7-pole connector atach		FK 1.1	/	K0000277	1	/
			FK 2.1				
			FK 3.1				
			FK 4.1				
6	Konektor, trojpolni, muski EP1100 S (EP3M+EP3GS) / 3-pole connector atach		FK 1.1	/	K0000278	2	/
			FK 2.1				
			FK 3.1				
			FK 4.1				
7	Ukrasna guma 3/4" / Decorative rubber 3/4"		FK 1.1	/	K0000170	7	/
			FK 2.1				
			FK 3.1				
			FK 4.1				
8	Plasticni ukrasni spoljni cep 1/2" / Decorative plastic outer cap 1/2"		FK 1.1	1/2"	K0000172	2	/
			FK 2.1	/	/	/	/
			FK 3.1	/	/	/	/
			FK 4.1	1/2"	K0000172	2	/
9	Plasticni ukrasni unutrasnji cep / Plastic decorative inner cap		FK 1.1	Ø26x9	K0000174	3	/
			FK 2.1				
			FK 3.1				
			FK 4.1				
10	Ukrasna guma 5/4" / Decorative rubber 3/4"		FK 1.1	/	/	/	/
			FK 2.1	/	/	/	/
			FK 3.1	Ø70.3x9	K0000232	2	/
			FK 4.1	/	/	/	/
11	Plasticni ukrasni spoljni cep 5/4" / Decorative plastic outer cap 5/4"		FK 1.1	/	/	/	/
			FK 2.1	/	/	/	/
			FK 3.1	Ø43x27	K0000230	2	/
			FK 4.1	/	/	/	/
12	Plasticni ukrasni unutrasnji cep 1" / Plastic decorative inner cap 1"		FK 1.1	Ø37x9	K0000228	2	/
			FK 2.1	/	/	/	/
			FK 3.1	/	/	/	/
			FK 4.1	Ø37x9	K0000228	2	/
13	Plasticni ukrasni spoljni cep 1" / Decorative plastic outer cap 1"		FK 1.1	1"	K0000171	2	/
			FK 2.1	/	/	/	/
			FK 3.1	/	/	/	/
			FK 4.1	/	/	/	/
14	Ukrasna guma 1" / Decorative rubber 1"		FK 1.1	1"	K0000168	4	/
			FK 2.1	/	/	/	/
			FK 3.1	/	/	/	/
			FK 4.1	/	/	/	/
15	Ukrasna guma 6/4" / Decorative rubber 6/4"		FK 1.1	/	/	/	/
			FK 2.1	/	/	/	/
			FK 3.1	6/4"	K0000001	2	/
			FK 4.1	/	/	/	/
16	Automatika TIEMME za FK kotlove / Complete control TIEMME		FK 1.1	/	K0000767	1	/
			FK 2.1				
			FK 3.1				
			FK 4.1				
17	Fex.rebrasto crevo Ø8 / Flexible ribbed pipe Ø8		FK 1.1	2,9m	K0001084	1	/
			FK 2.1	4,3m			
			FK 3.1	5,1m			
			FK 4.1	5,6m			
18	Fex.rebrasto crevo Ø8 / Flexible ribbed pipe Ø8		FK 1.1	0,7m	K0001086	1	/
			FK 2.1	1,2m			
			FK 3.1	1,3m			
			FK 4.1	1,4m			
19	Monofazni utikač sa uzemljenjem cmi 230 V, 16 A / Single phase plug		FK 1.1	/	K0001101	1	/
			FK 2.1				
			FK 3.1				
			FK 4.1				

20	3-polni konektor ženski EP1110 S (EP3F+EP3gS) / 3-pole connector		FK 1.1	/	K0001099		2	
			FK 2.1					
			FK 3.1					
			FK 4.1					
21	7-polni konektor ženski EP 1510 (EP7F+ EP7g) / 7-pole connector		FK 1.1	/	K0000540		1	
			FK 2.1					
			FK 3.1					
			FK 4.1					
22	Sigurnosni termostat 110-6°, C 250V ~, STB 115408 / Safety thermostat 110-6°, C 250V ~, STB 115408		FK 1.1	/	K0001345		1	
			FK 2.1					
			FK 3.1					
			FK 4.1					
23	Sonda dimovodnih gasova (TIEMMA) / Flue gas probe (TIEMME)		FK 1	2,5m	K0001362	00014017	1	
			FK 2					
			FK 3					
			FK 4					
24	Sonda za vodu (TIEMMA) / Water probe (TIEMME)		FK 1	2m	K0001478		1	
			FK 2					
			FK 3					
			FK 4					
25	Sonda za vodu u akumulatoru (TIEMMA) / Water probe in puffer (TIEMME)		FK 1	2m	K0001478		1	
			FK 2					
			FK 3					
			FK 4					