

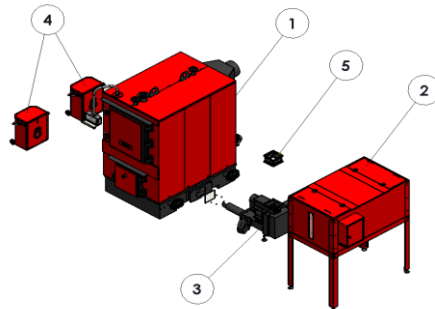

Radijator

INŽENJERING

REZERVNI DELOVI TKAN 60-300

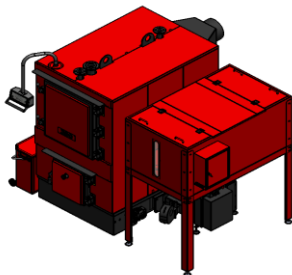







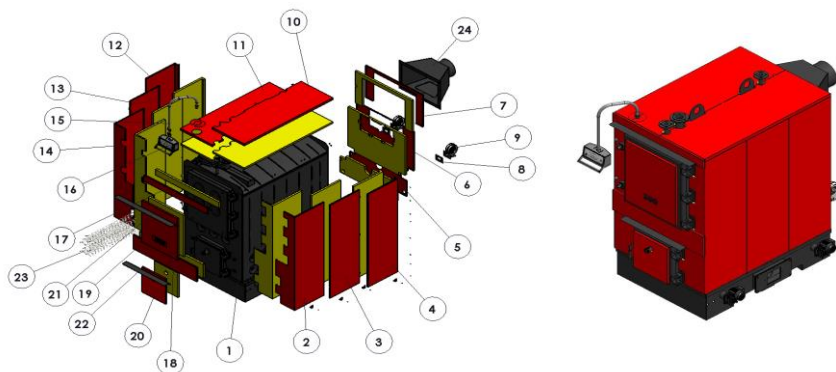





Spisak rezervnih delova za kotao TKAN 60 - TKAN 300 / List of spare parts for TKAN 60 - TKAN 300





| No. | Slika dela / pictures of parts | NAZIV / NAME | Tip kotla / Type of boiler | Dimenzija / Dimesion | CODE PDM | CODE INFOerp | Q. | Težina / Weight (kg) |
|----------|-----------------------------------|--|----------------------------------|--|----------|--------------|----|-------------------------|
| 1 | | ČIŠĆENJE KOTLA | TKAN 60 | 1520x700x1485 | SW-21283 | | 1 | 578 |
| | | | TKAN 80 | 1560x750x1785 | SW-21390 | | 1 | 845 |
| | | | TKAN 100 | 1720x1050x1785 | SW-21450 | | 1 | 925 |
| | | | TKAN 150 | 2210x1300x2007 | SW-21745 | | 1 | 1404 |
| | | | TKAN 200 | 2120x1470x2265 | SW-17760 | | 1 | 2035 |
| | | | TKAN 250 | 2530x1740x2330 | S0001473 | | 1 | 2598 |
| | | | TKAN 300 | 2720x1740x2330 | SW-17525 | | 1 | 2815 |
| 1 | | Kotao sa oplatom / Boiler of out side jacket | TKAN 60 | 1520x700x1485 | SW-21283 | | 1 | 578 |
| | | | TKAN 80 | 1560x750x1785 | SW-21390 | | 1 | 845 |
| | | | TKAN 100 | 1720x1050x1785 | SW-21450 | | 1 | 925 |
| | | | TKAN 150 | 2210x1300x2007 | SW-21745 | | 1 | 1404 |
| | | | TKAN 200 | 2120x1470x2265 | SW-17760 | | 1 | 2035 |
| | | | TKAN 250 | 2530x1740x2330 | S0001473 | | 1 | 2598 |
| | | | TKAN 300 | 2720x1740x2330 | SW-17525 | | 1 | 2815 |
| 2 | | Silos/Silos | TKAN 60 | 1114x750x1700 (0,45m ³) | SW-21693 | | 1 | 107 |
| | | | TKAN 80 | | | | | |
| | | | TKAN 100 | 1170x950x1600 (0,5m ³) | SW-16505 | | 1 | 113 |
| | | | TKAN 150 | 1460x1150x1850 (1,1m ³) | SW-14227 | | 1 | 167 |
| | | | TKAN 200 | 1420x1180x2000 (1,2m ³) | SW-17883 | | 1 | 176 |
| 3 | | Dozer / Feeder | TKAN 250 | 1760x1240x2050 (1,6m ³) | SW-15087 | | 1 | 215 |
| | | | TKAN 300 | | | | | |
| | | | TKAN 60 | L=788 | SW-21285 | 00015412 | 1 | 60 |
| | | | TKAN 80 | L=824 | SW-19599 | 00015413 | | 60,5 |
| | | | TKAN 100 | L=1132 | SW-15786 | 00015414 | | 141 |
| TKAN 150 | L=1164 | SW-11145 | 00015415 | 142 | | | | |
| TKAN 200 | L=1251 | SW-18857 | 00015416 | 145 | | | | |
| 4 | | Kutija za pepeo | TKAN 60 | / | / | | / | / |
| | | | TKAN 80 | | | | | |
| | | | TKAN 100 | 580x200x450 | S0000197 | | 1 | 13 |
| | | | TKAN 150 | | | | 2 | |
| | | | TKAN 200 | 490x340x610 | S0000185 | | 2 | 21 |
| | | | TKAN 250 | | | | | |
| 5 | | Fleksibilna veza / Flexible connection | TKAN 60 | 250x250x130 | S0003827 | | 1 | 1,5 |
| | | | TKAN 80 | | | | | |
| | | | TKAN 100 | | | | | |
| | | | TKAN 150 | | | | | |
| | | | TKAN 200 | | | | | |

KOTAO SA OPLATOM TKAN 60 - TKAN 300







| No. | Slika dela / Pictures of parts | Naziv / Name | Tip kotla / Type of boiler | Dimenzija / Dimesion | CODE PDM | CODE INFOerp | Q. | Težina / Weight (kg) | |
|----------|-----------------------------------|---|----------------------------------|----------------------|----------|--------------|----|-------------------------|------|
| 1 | | Telo kotla / Body of boiler | TKAN 60 | 700x906x1094 | SW-19959 | 00015283 | 1 | 537,00 | |
| | | | TKAN 80 | 750x955x1493 | SW-21385 | 00015284 | | 763,00 | |
| | | | TKAN 100 | 750x1155x1493 | SW-20338 | 00015285 | | 838,00 | |
| | | | TKAN 150 | 870x1370x1720 | SW-21687 | 00015286 | | 1287,00 | |
| | | | TKAN 200 | 1020x1418x1960 | SW-17746 | 00015287 | | 1878,00 | |
| | | | TKAN 250 | 1277x1530x2030 | SW-18183 | 00015288 | | 2408,00 | |
| | | | TKAN 300 | 1277x1770x2030 | SW-17479 | 00015289 | | 2613,00 | |
| 2 | | Bočna desna prednja strana oplata / Right side front panel | TKAN 60 | 160x915x990 | SW-21282 | 00015302 | 1 | 7,00 | |
| | | | TKAN 80 | 177x1114x1290 | SW-21391 | 00015303 | | 9,90 | |
| | | | TKAN 100 | 182x587x1290 | SW-21457 | 00015304 | | 6,20 | |
| | | | TKAN 150 | 198x680x1503 | SW-21747 | 00015305 | | 12,20 | |
| | | | TKAN 200 | 247x705x1720 | SW-17761 | 00015306 | | 14,60 | |
| | | | TKAN 250 | 376x493x1793 | SW-18352 | 00015309 | | 13,30 | |
| | | | TKAN 300 | 376x593x1793 | SW-17526 | 00015311 | | 15,00 | |
| 3 | | Bočna srednja desna strana oplata / Right middle side panel | TKAN 60 | / | / | / | 1 | / | |
| | | | TKAN 80 | / | / | / | | / | |
| | | | TKAN 100 | / | / | / | | / | |
| | | | TKAN 150 | / | / | / | | / | |
| | | | TKAN 200 | / | / | / | | / | |
| 4 | | Bočna zadnja desna strana oplata / Right side back panel | TKAN 250 | 593x1793 | D0003339 | 00015312 | 1 | 10,90 | |
| | | | TKAN 300 | / | SW-17529 | / | | 10,90 | |
| | | | TKAN 60 | / | / | / | | / | |
| 5 | | Zadnja donja strana oplata / Back lower panel | TKAN 80 | / | / | / | 1 | / | |
| | | | TKAN 100 | 587x1290 | SW-21499 | 00015313 | | 5,40 | |
| | | | TKAN 150 | 70x680x1503 | SW-21784 | 00015314 | | 11,40 | |
| | | | TKAN 200 | 70x705x1720 | SW-17765 | 00015315 | | 13,20 | |
| | | | TKAN 250 | 70x493x1793 | SW-18354 | 00015316 | | 10,30 | |
| | | | TKAN 300 | 70x593x1793 | SW-17530 | 00015317 | | 12,00 | |
| | | | TKAN 60 | 665x990 | SW-21292 | 00015330 | | 2,70 | |
| 6 | | Zadnja srednja strana oplata / Back middle panel | TKAN 80 | 646x714 | SW-21432 | 00015331 | 1 | 2,70 | |
| | | | TKAN 100 | 646x714 | D0015117 | 00015332 | | 2,60 | |
| | | | TKAN 150 | 370x737 | SW-21789 | 00015333 | | 2,80 | |
| | | | TKAN 200 | 370x887 | SW-17782 | 00015334 | | 3,20 | |
| | | | TKAN 250 | 360x1144 | SW-17544 | 00015335 | | 4,00 | |
| 7 | | Zadnja gornja strana oplata / Back upper panel | TKAN 60 | / | / | / | 1 | / | |
| | | | TKAN 80 | 596x737 | SW-21790 | 00015336 | | 3,20 | |
| | | | TKAN 200 | 735x887 | D0014038 | 00015337 | | 4,90 | |
| | | | TKAN 250 | 817x1144 | SW-17553 | 00015338 | | 7,40 | |
| 8 | | Guma na prirubnici ventilatora / Seal for fan | TKAN 60 | / | / | / | 1 | / | |
| | | | TKAN 80 | 646x714 | SW-21435 | 00015340 | | 0,90 | |
| | | | TKAN 100 | 646x714 | SW-21435 | 00015341 | | 0,90 | |
| | | | TKAN 150 | 537x737 | SW-21792 | 00015342 | | 1,00 | |
| | | | TKAN 200 | 613x887 | SW-17784 | 00015343 | | 1,40 | |
| 9 | | Guma na prirubnici ventilatora / Seal for fan | TKAN 250 | 616x1144 | SW-17559 | 00015344 | 1 | 2,70 | |
| | | | TKAN 300 | / | / | / | | / | |
| | | | TKAN 60 | 140x95x4 | K0000853 | / | | 1 | 0,04 |
| | | | TKAN 100 | / | / | / | | | |
| TKAN 150 | / | / | / | | | | | | |
| TKAN 200 | / | / | / | | | | | | |

| | | | | | | | | |
|----|---|---|----------|---------------|----------|----------|---|-------|
| 9 |  | Ventilator sekundarnog vazduha / Fan of secondary air | TKAN 60 | 160x210x180 | K0001121 | 00008041 | 1 | 5,70 |
| | | | TKAN 80 | | | | | |
| | | | TKAN 100 | | | | | |
| | | | TKAN 150 | | | | | |
| | | | TKAN 200 | | | | | |
| | | | TKAN 250 | | | | | |
| 10 |  | Krov oplate / Top panel | TKAN 60 | 700x915 | SW-21293 | 00015345 | 1 | 4,90 |
| | | | TKAN 80 | 750x1114 | SW-21414 | 00015346 | | 5,70 |
| | | | TKAN 100 | 750x1174 | SW-21461 | 00015347 | | 6,50 |
| | | Krov oplate - desni / Top panel - right | TKAN 150 | 435x1360 | SW-21800 | 00015348 | | 6,90 |
| | | | TKAN 200 | 510x1410 | SW-17786 | 00015349 | | 8,00 |
| | | | TKAN 250 | 638x1580 | SW-18362 | 00015350 | | 11,10 |
| 11 |  | Krov oplate - levi / Top panel - left | TKAN 60 | / | / | / | 1 | / |
| | | | TKAN 80 | / | / | / | | / |
| | | | TKAN 100 | / | / | / | | / |
| | | Bočna zadnja leva strana oplate / Left side back panel | TKAN 150 | 435x1360 | SW-21801 | 00015352 | | 6,70 |
| | | | TKAN 200 | 510x1410 | SW-17791 | 00015353 | | 8,00 |
| | | | TKAN 250 | 638x1580 | SW-18363 | 00015354 | | 10,90 |
| 12 |  | Bočna zadnja leva strana oplate / Left side back panel | TKAN 60 | / | / | / | 1 | / |
| | | | TKAN 80 | / | / | / | | / |
| | | | TKAN 100 | / | / | / | | / |
| | | Bočna srednja leva strana oplate / Left middle side panel | TKAN 150 | 587x1290 | SW-21500 | 00015325 | | 5,40 |
| | | | TKAN 200 | 70x680x1503 | SW-21787 | 00015326 | | 11,30 |
| | | | TKAN 250 | 70x705x1720 | SW-17769 | 00015327 | | 13,20 |
| 13 |  | Bočna srednja leva strana oplate / Left middle side panel | TKAN 60 | / | / | / | 1 | / |
| | | | TKAN 80 | / | / | / | | / |
| | | | TKAN 100 | / | / | / | | / |
| | | Bočna leva prednja strana oplate / Left side front panel | TKAN 150 | 615x1793x20 | D0003340 | / | | 10,90 |
| | | | TKAN 200 | 593x1793x20 | SW-17537 | / | | 10,90 |
| | | | TKAN 250 | 160x915x990 | SW-21291 | 00015318 | | 7,00 |
| 14 |  | Bočna leva prednja strana oplate / Left side front panel | TKAN 60 | 177x1114x1290 | SW-21391 | 00015319 | 1 | 9,90 |
| | | | TKAN 80 | 182x587x1290 | SW-21459 | 00015320 | | 6,30 |
| | | | TKAN 100 | 198x680x1503 | SW-21786 | 00015321 | | 12,70 |
| | | Sklop cevi automatike | TKAN 150 | 247x705x1720 | SW-17768 | 00015322 | | 15,00 |
| | | | TKAN 200 | 376x493x1793 | SW-18355 | 00015323 | | 13,60 |
| | | | TKAN 250 | 376x593x1793 | SW-17534 | 00015324 | | 15,60 |
| 15 |  | Sklop cevi automatike | TKAN 60 | / | / | / | 1 | / |
| | | | TKAN 80 | / | / | / | | / |
| | | | TKAN 100 | / | / | / | | / |
| | | Kućiče automatike | TKAN 150 | / | S0001433 | / | | 2,40 |
| | | | TKAN 200 | / | / | / | | / |
| | | | TKAN 250 | / | / | / | | / |
| 16 |  | Kućiče automatike | TKAN 60 | 100x306x135 | SW-3772 | / | 1 | 1,20 |
| | | | TKAN 80 | 180x170x300 | S0001436 | / | | 3,00 |
| | | | TKAN 100 | 77x700 | SW-21319 | 00015361 | | 0,73 |
| | | Prednja gornja strana oplate / Front panel - upper | TKAN 150 | 97x750 | SW-21415 | 00015362 | | 0,90 |
| | | | TKAN 200 | 121x870 | SW-21795 | 00015363 | | 1,80 |
| | | | TKAN 250 | 118x1020 | SW-17794 | 00015364 | | 2,00 |
| 17 |  | Prednja gornja strana oplate / Front panel - upper | TKAN 60 | 118x1277 | SW-17566 | 00015365 | 1 | 2,50 |
| | | | TKAN 80 | 440x463 | SW-21339 | 00015374 | | 1,80 |
| | | | TKAN 100 | 440x580 | SW-21442 | 00015375 | | 2,20 |
| | | Štitnik oplate gornjih vrata | TKAN 150 | 500x680 | D0004041 | 00015376 | | 4,20 |
| | | | TKAN 200 | 630x863 | SW-17797 | 00015377 | | 6,30 |
| | | | TKAN 250 | 713x801 | SW-9686 | 00015378 | | 6,60 |
| 18 |  | Štitnik oplate gornjih vrata | TKAN 60 | 112x700 | SW-21323 | 00015356 | 1 | 1,00 |
| | | | TKAN 80 | 267x750 | SW-21422 | 00015357 | | 1,80 |
| | | | TKAN 100 | 224x870 | SW-21794 | 00015358 | | 2,70 |
| | | Prednja donja lajsna oplate / Front panel - lower | TKAN 150 | 202x1020 | SW-17792 | 00015359 | | 2,90 |
| | | | TKAN 200 | 274x1277 | SW-17542 | 00015360 | | 4,50 |
| | | | TKAN 250 | 274x1277 | SW-17542 | 00015360 | | 4,50 |
| 19 |  | Prednja donja lajsna oplate / Front panel - lower | TKAN 60 | 276x336 | SW-21334 | 00015371 | 1 | 0,90 |
| | | | TKAN 80 | 430x430 | SW-21799 | 00015372 | | 2,60 |
| | | | TKAN 100 | 480x480 | SW-17405 | 00015373 | | 3,20 |
| | | Maska donjih vrata / Mask of lower door | TKAN 150 | 276x336 | SW-21334 | 00015371 | | 0,90 |
| | | | TKAN 200 | 430x430 | SW-21799 | 00015372 | | 2,60 |
| | | | TKAN 250 | 480x480 | SW-17405 | 00015373 | | 3,20 |
| 20 |  | Maska donjih vrata / Mask of lower door | TKAN 60 | 276x336 | SW-21334 | 00015371 | 1 | 0,90 |
| | | | TKAN 80 | 430x430 | SW-21799 | 00015372 | | 2,60 |
| | | | TKAN 100 | 480x480 | SW-17405 | 00015373 | | 3,20 |
| | | Maska donjih vrata / Mask of lower door | TKAN 150 | 276x336 | SW-21334 | 00015371 | | 0,90 |
| | | | TKAN 200 | 430x430 | SW-21799 | 00015372 | | 2,60 |
| | | | TKAN 250 | 480x480 | SW-17405 | 00015373 | | 3,20 |

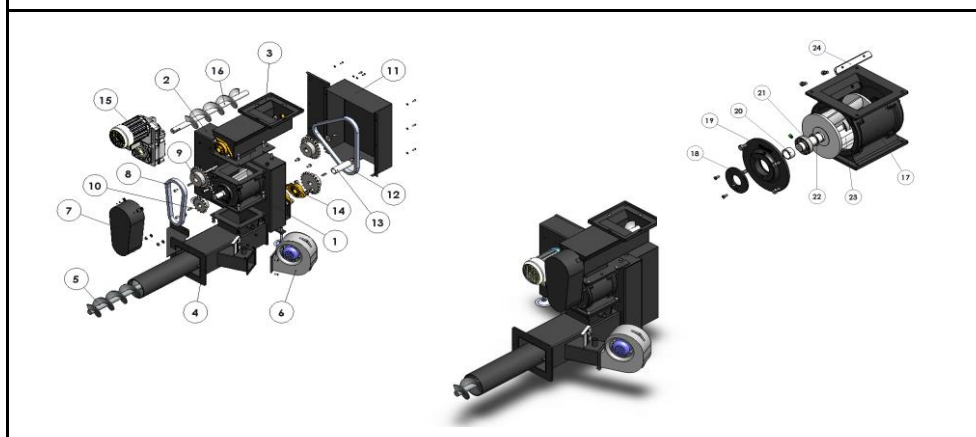





| | | | | | | | | |
|----------|---|--|----------|--------------|----------|----------|------|-------|
| 21 |  | Štitnik od plamena - gornji / Guard of flame upper | TKAN 60 | / | / | / | / | / |
| | | | TKAN 80 | | | | | |
| | | | TKAN 100 | | | | | |
| | | | TKAN 150 | | | | | |
| | | | TKAN 200 | 916 | SW-17795 | 00015369 | 1 | 1,50 |
| TKAN 250 | 1140 | SW-17573 | 00015370 | 1,90 | | | | |
| 22 |  | Štitnik od plamena - donji / Guard of flame lower | TKAN 60 | 576 | SW-21349 | 00015366 | 2 | 0,85 |
| | | | TKAN 80 | | | | | |
| | | | TKAN 100 | | | | | |
| | | | TKAN 150 | 760 | D0016207 | 00015367 | | 1,20 |
| | | | TKAN 200 | | SW-17796 | | 1,10 | |
| 23 |  | Turbulator / Turbulator | TKAN 60 | Ø50 x 600 mm | D0008914 | / | 23 | 0,30 |
| | | | TKAN 80 | | | | 30 | |
| | | | TKAN 100 | | | | | |
| | | | TKAN 150 | | | | 40 | |
| | | | TKAN 200 | Ø63 x 900 mm | D0008913 | / | 47 | 0,60 |
| TKAN 250 | 55 | | | | | | | |
| TKAN 300 | 55 | | | | | | | |
| 24 |  | Dimnjača / Chimneys | TKAN 60 | 320x520x404 | SW-20094 | 00015290 | 1 | 17,20 |
| | | | TKAN 80 | 472x622x350 | SW-20351 | 00015291 | | 19,30 |
| | | | TKAN 100 | | | | | |
| | | | TKAN 150 | 470x650x500 | SW-21722 | 00015292 | | 32,50 |
| | | | TKAN 200 | 558x750x500 | SW-17613 | 00015293 | | 37,30 |
| TKAN 250 | 534x830x564 | SW-17450 | 00015294 | | 46,00 | | | |
| TKAN 300 | | | | | | | | |

DOZER TKAN 60 - TKAN 300



| No. | Slika dela / pictures of parts | DELOVI | Tip kotla / Type of boiler | Dimenzija / Dimesion | CODE PDM | CODE INFOerp | Q. | Težina / Weight (kg) |
|----------|---|---|----------------------------|----------------------|----------|--------------|----|----------------------|
| 1 |  | Valvola-čelijski transporter / Cell wheel | TKAN 60 | 172x155x109 | SW-3808 | 00015418 | 1 | 9,20 |
| | | | TKAN 80 | | | | | |
| | | | TKAN 100 | 212x220x210 | SW-2555 | 00015419 | | 22,00 |
| | | | TKAN 150 | | | | | |
| | | | TKAN 200 | | | | | |
| 2 |  | Kutija lancanika | TKAN 60 | 320x350x80 | D0004998 | | 1 | 5,40 |
| | | | TKAN 80 | | | | | |
| | | | TKAN 100 | 460x585x120 | D0012052 | | | 12,20 |
| | | | TKAN 150 | | | | | |
| | | | TKAN 200 | | | | | |
| 3 |  | Gornji sklop dozera | TKAN 60 | 357x225x330 | SW-2499 | | 1 | 8,60 |
| | | | TKAN 80 | | | | | |
| | | | TKAN 100 | 570x320x197 | SW-2587 | | | 17,80 |
| | | | TKAN 150 | | | | | |
| | | | TKAN 200 | | | | | |
| TKAN 250 | 570x320x195 | SW-12126 | | 18,20 | | | | |
| TKAN 300 | | | | | | | | |

| | | | | | | | | |
|----|---|--|----------|-------------------------|----------|----------|---|-------|
| 4 |  | Sklop donje kutije dozera | TKAN 60 | 609x336x208 | S0001386 | | 1 | 12,10 |
| | | | TKAN 80 | 645x208x336 | S0001307 | | | 11,80 |
| | | | TKAN 100 | 837x404x270 | SW-2662 | | | 23,20 |
| | | | TKAN 150 | 870,5x404x270 | S0001356 | | | 23,50 |
| | | | TKAN 200 | 955x404x270 | S0001365 | | | 24,30 |
| | | | TKAN 250 | 912x404x270 | SW-12095 | | | 25,40 |
| 5 |  | Donja spirala / Lowe feeder spiral | TKAN 60 | Ø60/60x769 | SW-21288 | 00015420 | 1 | 2,80 |
| | | | TKAN 80 | Ø60/60x805 | SW-19605 | 00015421 | | 2,90 |
| | | | TKAN 100 | Ø80/80x1117 | SW-15588 | 00015422 | | 8,20 |
| | | | TKAN 150 | Ø80/80x1200 | SW-11165 | 00015423 | | 8,90 |
| | | | TKAN 200 | Ø80/80x1237 | SW-17955 | 00015424 | | 9,20 |
| | | | TKAN 250 | Ø100/100x1267 | SW-12150 | 00015425 | | 10,50 |
| 6 |  | Ventilator | TKAN 60 | WPA120 | K0001121 | | 1 | 5,70 |
| | | | TKAN 80 | | | | | |
| | | | TKAN 100 | | | | | |
| | | | TKAN 150 | VC14LA/H15, 230V | K0000987 | | | 2,80 |
| | | | TKAN 200 | | | | | |
| 7 |  | Poklopac lančanika / Cover chainwheel | TKAN 60 | 160x280x90 | S0000682 | 00015431 | 1 | 0,65 |
| | | | TKAN 80 | | | | | |
| | | | TKAN 100 | | | | | |
| | | | TKAN 150 | 160x343x105 | S0001060 | 00015432 | | 1,10 |
| | | | TKAN 200 | | | | | |
| 8 |  | Prenosnik snage - Lanac kraći / Power transmission chain - shorter | TKAN 60 | 3 - korak 12.7 - članak | D0016699 | 00011506 | 1 | / |
| | | | TKAN 80 | | | | | |
| | | | TKAN 100 | | | | | |
| | | | TKAN 150 | 3-1 korak 19.05 članak | D0016693 | | | / |
| | | | TKAN 200 | | | | | |
| 9 |  | Lančanik / Chainwheel | TKAN 60 | 33Z 08B DIN 8192 | K0000090 | 00011534 | 1 | / |
| | | | TKAN 80 | | | | | |
| | | | TKAN 100 | | | | | |
| | | | TKAN 150 | 22Z 12B-1 DIN 8192 | K0000037 | | | 3 |
| | | | TKAN 200 | | | | | |
| 10 |  | Lančanik / Chainwheel | TKAN 60 | 083 Z18 | K0000089 | 00011508 | 2 | / |
| | | | TKAN 80 | | | | | |
| | | | TKAN 100 | | | | | |
| | | | TKAN 150 | 15Z 12B-1 DIN 8192 | K0000036 | | | 1 |
| | | | TKAN 200 | | | | | |
| 11 |  | Poklopac kutije lančanika / Cover chainwheel | TKAN 60 | 356x323x95 | SW-4954 | 00015433 | 1 | 2,03 |
| | | | TKAN 80 | | | | | |
| | | | TKAN 100 | | | | | |
| | | | TKAN 150 | 365x463x135 | SW-2642 | 00015434 | | 3,90 |
| | | | TKAN 200 | | | | | |
| 12 |  | Prenosnik snage - Lanac duži / Power transmission chain - longer | TKAN 60 | 3 - korak 12.7 - članak | D0016700 | 00011506 | 1 | / |
| | | | TKAN 80 | | | | | |
| | | | TKAN 100 | | | | | |
| | | | TKAN 150 | 3-1 korak 19.05 članak | D0016695 | | | 1 |
| | | | TKAN 200 | | | | | |
| 13 |  | Distantna čaura drugog ležaja | TKAN 60 | Ø25x20 | SW-4512 | | 1 | 0,05 |
| | | | TKAN 80 | | | | | |
| | | | TKAN 100 | | | | | |
| | | | TKAN 150 | Ø38x118,9 | SW-10312 | | | 0,40 |
| | | | TKAN 200 | | | | | |
| 14 |  | Ležaj / Bearing | TKAN 60 | UCFL 204 | K0000096 | 00012290 | 4 | / |
| | | | TKAN 80 | | | | | |
| | | | TKAN 100 | | | | | |
| | | | TKAN 150 | UCFL 206 - dm30 | K0000100 | | | 4 |
| | | | TKAN 200 | | | | | |
| 15 |  | Motor - reduktor | TKAN 60 | ABM 0.090kw | K0000401 | | 1 | 9,70 |
| | | | TKAN 80 | | | | | |
| | | | TKAN 100 | | | | | |
| | | | TKAN 150 | ABM 0.75kw | K0001108 | | | 1 |
| | | | TKAN 200 | | | | | 34,30 |
| | | | TKAN 250 | | | | | |
| | | | TKAN 300 | | | | | |

| | | | | | | | | | |
|----|---|---|----------|---------------------|-------------------|----------|---|-------------|--|
| 16 |  | Gornja spirala dozera / Upper feeder spiral | TKAN 60 | Ø60/60x334 | SW-2507 | 00015426 | 1 | 1,10 | |
| | | | TKAN 80 | | | | | | |
| | | | TKAN 100 | | | | | | |
| | | | TKAN 150 | Ø80/80x479 | SW-2603 | 00015427 | 1 | 4,10 | |
| | | | TKAN 200 | | | | | | |
| 17 |  | Kucišta valvole-čelijski transporter / Hausing Cell wheel | TKAN 60 | 172x108x155 | SW-3802 | | 1 | 5,70 | |
| | | | TKAN 80 | | | | | | |
| | | | TKAN 100 | | | | | | |
| | | | TKAN 150 | 210x220x208 | SW-2553 | | 1 | 13,15 | |
| | | | TKAN 200 | | | | | | |
| 18 |  | Poklopac velike valvole - Manji / Cover cell wheel | TKAN 60 | / | / | / | / | / | |
| | | | TKAN 80 | | | | | | |
| | | | TKAN 100 | | | | | | |
| | | | TKAN 150 | Ø91x8,7 | SW-2566 | | 2 | 0,23 | |
| | | | TKAN 200 | | | | | | |
| 19 |  | Poklopac valvole - Veći / Cover cell wheel | TKAN 60 | Ø140x15 | SW-3804 | | 1 | 1,20 | |
| | | | TKAN 80 | | | | | | |
| | | | TKAN 100 | | | | | | |
| | | | TKAN 150 | Ø190x24,5 | SW-2551 | | 2 | 2,50 | |
| | | | TKAN 200 | | | | | | |
| 20 |  | Čaura rotora veća/manja | TKAN 60 | Ø25 x 30 / Ø25 x 26 | SW-3806 / SW-3807 | | 1 | 0,03 | |
| | | | TKAN 80 | | | | | | |
| | | | TKAN 100 | | | | | | |
| | | | TKAN 150 | Ø35x30 / Ø35x18,5 | W-2630/SW-26 | | 1 | 0,06 / 0,04 | |
| | | | TKAN 200 | | | | | | |
| 21 |  | Ležaj / Bearing | TKAN 60 | 6004 2RS | K0000104 | 00008401 | 2 | / | |
| | | | TKAN 80 | | | | | | |
| | | | TKAN 100 | | | | | | |
| | | | TKAN 150 | 6206 DIN 625 | K0000102 | | 2 | / | |
| | | | TKAN 200 | | | | | | |
| 22 |  | Metalna zaptivka za ležaj | TKAN 60 | / | / | / | / | / | |
| | | | TKAN 80 | | | | | | |
| | | | TKAN 100 | | | | | | |
| | | | TKAN 150 | Ø41,9x1,8 | K0001412 | | 2 | / | |
| | | | TKAN 200 | | | | | | |
| 23 |  | Rotor valvole | TKAN 60 | Ø110x210 | SW-3803 | | 1 | 2,14 | |
| | | | TKAN 80 | | | | | | |
| | | | TKAN 100 | | | | | | |
| | | | TKAN 150 | Ø160x358,6 | SW-2614 | | 1 | 3,10 | |
| | | | TKAN 200 | | | | | | |
| 24 |  | Nož velike valvole | TKAN 60 | / | / | / | / | / | |
| | | | TKAN 80 | | | | | | |
| | | | TKAN 100 | | | | | | |
| | | | TKAN 150 | 150x23x8 | SW-12231 | | 1 | 0,20 | |
| | | | TKAN 200 | | | | | | |

SKLOP KOTLA TKAN 60 - TKAN 300

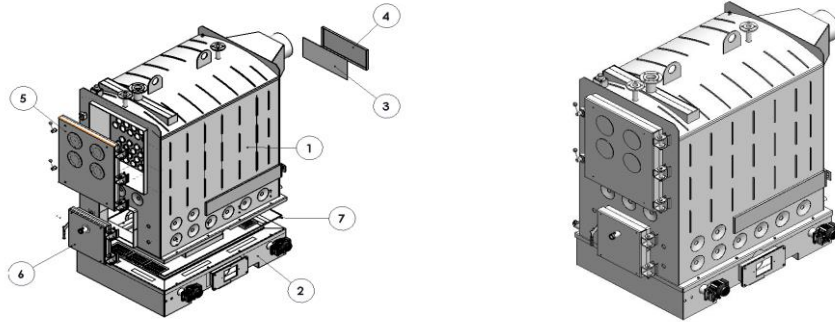





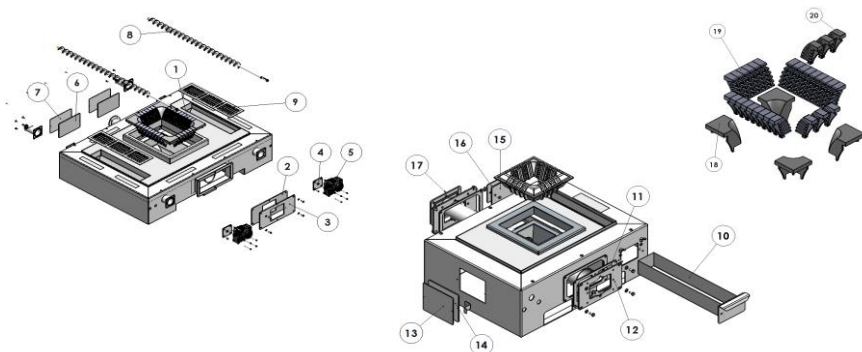





| No. | Slika dela / pictures of parts | DELOVI | Tip kotla / Type of boiler | Dimenzija / Dimesion | CODE PDM | CODE INFOerp | Q. | Težina / Weight (kg) |
|-----|-----------------------------------|---|----------------------------------|----------------------|----------|--------------|----|-------------------------|
| 1 | | Sklop izmenjivača / Exchanger | TKAN 60 | 1003x700x1115 | SW-19984 | | 1 | 309,00 |
| | | | TKAN 80 | 1091x750x1420 | SW-20916 | | | 469,00 |
| | | | TKAN 100 | 1250x750x1450 | SW-20302 | | | 522,00 |
| | | | TKAN 150 | 1430x905x1680 | SW-21146 | | | 860,00 |
| | | | TKAN 200 | 1549x1020x1900 | SW-17034 | | | 1298,00 |
| | | | TKAN 250 | 1732x1277x2000 | SW-18229 | | | 1683,00 |
| | | | TKAN 300 | 1932x1277x2000 | SW-16690 | | | 1846,00 |
| 2 | | Ložište / Combustion chamber | TKAN 60 | 320x680x890 | SW-19381 | 00015379 | 1 | 129,00 |
| | | | TKAN 80 | 320x730x975 | SW-1560 | 00015380 | | 183,00 |
| | | | TKAN 100 | 320x730x1135 | SW-2394 | 00013886 | | 201,00 |
| | | | TKAN 150 | 360x850x1350 | SW-11162 | 00015381 | | 254,00 |
| | | | TKAN 200 | 360x1005x1400 | SW-1909 | 00015382 | | 345,00 |
| | | | TKAN 250 | 360x1260x1500 | SW-12287 | 00015383 | | 462,00 |
| | | | TKAN 300 | 360x1260x1750 | SW-12718 | 00015384 | | 505,00 |
| 3 | | Izolacija zadnjeg poklopca za čišćenje | TKAN 60 | 363x210x5 | SW-19972 | | 1 | 0,40 |
| | | | TKAN 80 | 332x252x5 | SW-20443 | | | 0,40 |
| | | | TKAN 100 | 410x260x5 | SW-21744 | | | 0,50 |
| | | | TKAN 150 | 410x260x5 | SW-21744 | | | 0,70 |
| | | | TKAN 200 | 540x270x5 | SW-17628 | | | 0,80 |
| | | | TKAN 250 | 640x270x5 | SW-8869 | | | 0,80 |
| | | | TKAN 300 | 640x270x5 | SW-8869 | | | 0,80 |
| 4 | | Sklop zadnjeg poklopca za čišćenje | TKAN 60 | 373x220x30 | SW-19970 | | 1 | 3,50 |
| | | | TKAN 80 | 340x260x30 | SW-20441 | | | 3,70 |
| | | | TKAN 100 | 420x270x30 | SW-21742 | | | 5,70 |
| | | | TKAN 150 | 550x280x30 | SW-17627 | | | 7,50 |
| | | | TKAN 200 | 550x280x30 | SW-17627 | | | 7,50 |
| | | | TKAN 250 | 650x280x30 | SW-8870 | | | 8,80 |
| | | | TKAN 300 | 650x280x30 | SW-8870 | | | 8,80 |
| 5 | | Gornja vrata / Upper door | TKAN 60 | 470x503x100 | SW-19677 | | 1 | 36,00 |
| | | | TKAN 80 | 620x480x100 | SW-20401 | | | 43,00 |
| | | | TKAN 100 | 720x540x100 | SW-21698 | | | 58,00 |
| | | | TKAN 150 | 720x540x100 | SW-21698 | | | 58,00 |
| | | | TKAN 200 | 903x676x100 | SW-17585 | | | 90,00 |
| | | | TKAN 250 | 901x813x100 | SW-8654 | | | 104,00 |
| | | | TKAN 300 | 901x813x100 | SW-8654 | | | 104,00 |
| 6 | | Donja vrata / Lower door | TKAN 60 | 376x316x150 | S0001012 | | 1 | 8,20 |
| | | | TKAN 80 | 376x316x212 | SW-19693 | | | 27,00 |
| | | | TKAN 100 | 500x470x212 | SW-21748 | | | 49,00 |
| | | | TKAN 150 | 500x470x212 | SW-21748 | | | 49,00 |
| | | | TKAN 200 | 550x520x212 | SW-17356 | | | 60,00 |
| | | | TKAN 250 | 550x520x212 | SW-17356 | | | 60,00 |
| | | | TKAN 300 | 550x520x212 | SW-17356 | | | 60,00 |
| 7 | | Pletenica ložišta / Ceramic rope of Combustion chamber | TKAN 60 | 10x10x2800 | D0004581 | | 1 | / |
| | | | TKAN 80 | 10x10x3110 | D0003394 | | | / |
| | | | TKAN 100 | 10x10x3300 | D0005558 | | | / |
| | | | TKAN 150 | 10x10x4200 | D0003379 | | | / |
| | | | TKAN 200 | 10x10x4576 | D0004335 | | | / |
| | | | TKAN 250 | 10x10x5280 | D0004391 | | | / |
| | | | TKAN 300 | 10x10x5782 | D0004583 | | | / |

LOŽIŠTE TKAN 60 - TKAN 300















| No. | Slika dela / pictures of parts | DELOVI | Tip kotla / Type of boiler | Dimenzija / Dimesion | CODE PDM | CODE INFOerp | Q. | Težina / Weight (kg) |
|----------|-----------------------------------|--|----------------------------------|----------------------|----------|--------------|----|-------------------------|
| 1 | | Sklop livenih segmenata | TKAN 60 | 280x280x105 | SW-9974 | | 1 | 15,50 |
| | | | TKAN 80 | 280x312x105 | SW-15203 | | | 16,50 |
| | | | TKAN 100 | 312x312x105 | SW-15029 | | | 17,50 |
| | | | TKAN 150 | 344x376x105 | SW-13257 | | | 20,50 |
| | | | TKAN 200 | 506x506x155 | S0002669 | | | 64,50 |
| | | | TKAN 250 | 506x586x155 | S0002668 | | | 70,00 |
| | | | TKAN 300 | 626x506x155 | S0002679 | | | 74,00 |
| 2 | | Izolacija prirubnice ložišta / Insolation of flange of combustion chamber | TKAN 60 | / | / | / | 2 | / |
| | | | TKAN 80 | 349x230x5 | SW-15212 | | | 0,30 |
| | | | TKAN 100 | / | / | / | 1 | 0,25 |
| | | | TKAN 150 | 349x230x5 | SW-6556 | | | |
| | | | TKAN 200 | / | / | / | | |
| | | | TKAN 250 | 499x230x5 | SW-12294 | | | |
| TKAN 300 | / | / | / | / | / | | | |
| 3 | | Prirubnica ložišta / Flange of combustion chamber | TKAN 60 | / | / | / | 2 | / |
| | | | TKAN 80 | 349x230x6 | SW-15211 | | | 3,00 |
| | | | TKAN 100 | / | / | / | 1 | 2,40 |
| | | | TKAN 150 | 349x230x6 | SW-6555 | | | |
| | | | TKAN 200 | / | / | / | | |
| | | | TKAN 250 | 499x230x6 | SW-12300 | | | |
| TKAN 300 | / | / | / | / | / | | | |
| 4 | | Adapter ploča ložišta | TKAN 60 | / | / | / | 1 | / |
| | | | TKAN 80 | / | / | / | | / |
| | | | TKAN 100 | / | / | / | 2 | 0,80 |
| | | | TKAN 150 | 120x120x8 | SW-12447 | | | |
| | | | TKAN 200 | / | / | / | | |
| | | | TKAN 250 | / | / | / | | |
| TKAN 300 | / | / | / | / | / | | | |
| 5 | | Motor-reduktor | TKAN 60 | / | / | / | 1 | / |
| | | | TKAN 80 | / | / | / | | / |
| | | | TKAN 100 | / | / | / | 2 | 9,70 |
| | | | TKAN 150 | ABM 0.090kw | K0000401 | | | |
| | | | TKAN 200 | / | / | / | | |
| | | | TKAN 250 | / | / | / | | |
| TKAN 300 | / | / | / | / | / | | | |
| 6 | | Izolacioni karton proreza za čišćenje ložišta | TKAN 60 | / | / | / | 2 | / |
| | | | TKAN 80 | / | / | / | | / |
| | | | TKAN 100 | / | / | / | 2 | 0,20 |
| | | | TKAN 150 | 250x170x5 | D0000235 | | | |
| | | | TKAN 200 | / | / | / | | |
| TKAN 250 | 300x190x5 | SW-12302 | | 0,27 | | | | |
| TKAN 300 | / | / | / | / | / | | | |
| 7 | | Poklopac proreza za čišćenje ložišta | TKAN 60 | / | / | / | 2 | / |
| | | | TKAN 80 | / | / | / | | / |
| | | | TKAN 100 | / | / | / | 2 | 1,00 |
| | | | TKAN 150 | 250x170x3 | D0000236 | | | |
| | | | TKAN 200 | / | / | / | | |
| TKAN 250 | 300x190x2 | SW-12303 | | 0,90 | | | | |
| TKAN 300 | / | / | / | / | / | | | |
| 8 | | Sklop spirale automatskog čišćenja/ Feeder spiral for cleaning | TKAN 60 | / | / | / | 1 | / |
| | | | TKAN 80 | / | / | / | | / |
| | | | TKAN 100 | Ø60/60x1142 | S0002869 | 00015400 | 2 | 3,90 |
| | | | TKAN 150 | Ø60/60x1262 | SW-13270 | 00015401 | | |
| | | | TKAN 200 | Ø60/60x1485 | SW-15360 | 00015402 | | |
| | | | TKAN 250 | Ø60/60x1740 | SW-12446 | 00015403 | | |
| TKAN 300 | / | / | / | / | / | | | |
| TKAN 60 | / | / | / | / | / | | | |
| 9 | | Rešetka na ložištu / Gridd on combustion chamber | TKAN 60 | / | / | / | 2 | / |
| | | | TKAN 80 | / | / | / | | / |
| | | | TKAN 100 | 157x534 | SW-15024 | 00015405 | 2 | 3,00 |
| | | | TKAN 150 | 157x624 | SW-13269 | 00015406 | | |
| | | | TKAN 200 | / | / | / | | |
| | | | TKAN 250 | 190x740 | SW-15366 | 00015407 | | |
| TKAN 300 | / | / | / | / | / | | | |
| TKAN 60 | / | / | / | / | / | | | |
| TKAN 80 | / | / | / | / | / | | | |
| TKAN 100 | 157x534 | SW-15024 | 00015405 | 2 | 3,00 | | | |
| TKAN 150 | 157x624 | SW-13269 | 00015406 | | | | | |
| TKAN 200 | / | / | / | | | | | |
| TKAN 250 | 190x740 | SW-15366 | 00015407 | | | | | |
| TKAN 300 | / | / | / | / | / | | | |

| | | | | | | | | | | | |
|----|---|--|----------|-------------|----------|----------|----|-------|--|--|----|
| 10 |  | Pepejlara | TKAN 60 | 636x185x120 | SW-9952 | | 1 | 1,90 | | | |
| | | | TKAN 80 | | | | | | | | |
| | | | TKAN 100 | | | | | | | | |
| | | | TKAN 150 | / | / | / | / | / | | | |
| | | | TKAN 200 | | | | | | | | |
| | | | TKAN 300 | | | | | | | | |
| 11 |  | Izolacioni karton bočne prirubnice | TKAN 60 | 300x173x5 | SW-4971 | | 2 | 0,07 | | | |
| | | | TKAN 80 | | | | | | | | |
| | | | TKAN 100 | | | | | | | | |
| | | | TKAN 150 | / | / | / | / | / | | | |
| | | | TKAN 200 | | | | | | | | |
| | | | TKAN 300 | | | | | | | | |
| 12 |  | Bočna prirubnica ložišta | TKAN 60 | 300x173x6 | SW-15382 | | 2 | 1,65 | | | |
| | | | TKAN 80 | | | | | | | | |
| | | | TKAN 100 | | | | | | | | |
| | | | TKAN 150 | / | / | / | / | / | | | |
| | | | TKAN 200 | | | | | | | | |
| | | | TKAN 300 | | | | | | | | |
| 13 |  | Poklopac prednje strane ložišta | TKAN 60 | 210x180x3 | SW-1753 | | 1 | 0,90 | | | |
| | | | TKAN 80 | | | | | | | | |
| | | | TKAN 100 | | | | | | | | |
| | | | TKAN 150 | / | / | / | / | / | | | |
| | | | TKAN 200 | | | | | | | | |
| | | | TKAN 300 | | | | | | | | |
| 14 |  | Izolacioni karton prednjeg poklopca | TKAN 60 | 210x180x5 | SW-1755 | | 1 | 0,18 | | | |
| | | | TKAN 80 | | | | | | | | |
| | | | TKAN 100 | | | | | | | | |
| | | | TKAN 150 | / | / | / | / | / | | | |
| | | | TKAN 200 | | | | | | | | |
| | | | TKAN 300 | | | | | | | | |
| 15 |  | Izolacioni karton bočnog proreza pepeljare | TKAN 60 | 185x120x5 | SW-1827 | | 1 | 0,10 | | | |
| | | | TKAN 80 | | | | | | | | |
| | | | TKAN 100 | | | | | | | | |
| | | | TKAN 150 | / | / | / | / | / | | | |
| | | | TKAN 200 | | | | | | | | |
| | | | TKAN 300 | | | | | | | | |
| 16 |  | Poklopac bočnog prpreza pepeljare | TKAN 60 | 185x120x3 | SW-1828 | | 1 | 0,50 | | | |
| | | | TKAN 80 | | | | | | | | |
| | | | TKAN 100 | | | | | | | | |
| | | | TKAN 150 | / | / | / | / | / | | | |
| | | | TKAN 200 | | | | | | | | |
| | | | TKAN 300 | | | | | | | | |
| 17 |  | Sklop bočnog poklopca ložišta | TKAN 60 | 320x210x160 | S0000077 | 00015397 | 1 | 5,40 | | | |
| | | | TKAN 80 | 380x210x160 | SW-1793 | 00015398 | | 6,30 | | | |
| | | | TKAN 100 | 380x270x230 | SW-2419 | 15399 | | 10,30 | | | |
| | | | TKAN 150 | / | / | / | / | / | | | |
| | | | TKAN 200 | | | | | | | | |
| | | | TKAN 300 | | | | | | | | |
| 18 |  | Ugaoni liveni segment / Casting segment - corner | TKAN 60 | 76x76x95 | K0000289 | 00011954 | 4 | 1,90 | | | |
| | | | TKAN 80 | | | | | | | | |
| | | | TKAN 100 | | | | | | | | |
| | | | TKAN 150 | 113x113x155 | K0000651 | | | 4,43 | | | |
| | | | TKAN 200 | | | | | | | | |
| | | | TKAN 300 | | | | | | | | |
| 19 |  | Otvoreni segment / Casting segment - open | TKAN 60 | 76x32x105 | K0000291 | 00011952 | 8 | 0,46 | | | |
| | | | TKAN 80 | | | | | | | | 9 |
| | | | TKAN 100 | | | | | | | | 10 |
| | | | TKAN 150 | 40x120x150 | K0000652 | | 13 | 1,90 | | | |
| | | | TKAN 200 | | | | | | | | 22 |
| | | | TKAN 300 | | | | | | | | 25 |
| 20 |  | Zatvoreni segment / Casting segment - closed | TKAN 60 | 76x32x105 | K0000290 | 00011953 | 8 | 0,55 | | | |
| | | | TKAN 80 | | | | | | | | 9 |
| | | | TKAN 100 | | | | | | | | 10 |
| | | | TKAN 150 | 40x120x150 | K0000653 | | 13 | 2,00 | | | |
| | | | TKAN 200 | | | | | | | | 2 |
| | | | TKAN 300 | | | | | | | | 3 |

| DONJA VRATA TKAN 60 - TKAN 300 | | GORNJA VRATA TKAN 60 - TKAN 300 | | | | | | |
|--------------------------------|-----------------------------------|---------------------------------|---------------------------------|----------------------|----------|--------------|----|-------------------------|
| | | | | | | | | |
| No. | Slika dela / pictures of parts | DELOVI | Tip kota / Type of bolter | Dimenzija / Dimesion | CODE PDM | CODE INFOerp | Q. | Težina / Weight (kg) |
| 1 | | Plastična ručica sa umetkom | TKAN 60 | 30x100 (M12) | K0000155 | 00000175 | 1 | 0,20 |
| | | | TKAN 80 | | | | | |
| | | | TKAN 100 | | | | | |
| | | | TKAN 150 | | | | | |
| | | | TKAN 200 | | | | | |
| | | | TKAN 250 | | | | | |
| 2 | | Ručica za donja vrata | TKAN 60 | 128x102 (M12) | SW-3720 | | 1 | 0,20 |
| | | | TKAN 80 | | | | | |
| | | | TKAN 100 | | | | | |
| | | | TKAN 150 | | | | | |
| | | | TKAN 200 | | | | | |
| | | | TKAN 250 | | | | | |
| 3 | | Nosач ručice | TKAN 60 | D 10 | K0000823 | | 1 | / |
| | | | TKAN 80 | | | | | |
| | | | TKAN 100 | | | | | |
| | | | TKAN 150 | | | | | |
| | | | TKAN 200 | | | | | |
| | | | TKAN 250 | | | | | |
| 4 | | Podloška zakrivljena | TKAN 60 | D10 DIN 137 tip A | K0000222 | | 1 | / |
| | | | TKAN 80 | | | | | |
| | | | TKAN 100 | | | | | |
| | | | TKAN 150 | | | | | |
| | | | TKAN 200 | | | | | |
| | | | TKAN 250 | | | | | |
| 5 | | Poklopac revizora | TKAN 60 | Ø56x22 | K0000832 | | 1 | 0,05 |
| | | | TKAN 80 | | | | | |
| | | | TKAN 100 | | | | | |
| | | | TKAN 150 | | | | | |
| | | | TKAN 200 | | | | | |
| | | | TKAN 250 | | | | | |
| 6 | | Pletenica donjih vrata | TKAN 60 | 20x20x1344 | SW-19694 | | 1 | 0,40 |
| | | | TKAN 80 | | | | | |
| | | | TKAN 100 | | | | | |
| | | | TKAN 150 | | | | | |
| | | | TKAN 200 | | | | | |
| | | | TKAN 250 | | | | | |
| 7 | | Blinda gornjih vrata | TKAN 60 | Ø200x100 | SW-18820 | | 1 | 1,30 |
| | | | TKAN 80 | | | | | |
| | | | TKAN 100 | | | | | |
| | | | TKAN 150 | | | | | |
| | | | TKAN 200 | | | | | |
| | | | TKAN 250 | | | | | |
| 8 | | Pletenica gornjih vrata | TKAN 60 | 18x18x1926 | SW-19679 | | 1 | 0,57 |
| | | | TKAN 80 | | | | | |
| | | | TKAN 100 | | | | | |
| | | | TKAN 150 | | | | | |
| | | | TKAN 200 | | | | | |
| | | | TKAN 250 | | | | | |
| 9 | | Izolacioni karton blinde | TKAN 60 | Ø210x5 | SW-18821 | | 1 | 0,16 |
| | | | TKAN 80 | | | | | |
| | | | TKAN 100 | | | | | |
| | | | TKAN 150 | | | | | |
| | | | TKAN 200 | | | | | |
| | | | TKAN 250 | | | | | |
| 10 | | Unutrašnja priрубica blinde | TKAN 60 | Ø210x5 | SW-18822 | | 1 | 1,40 |
| | | | TKAN 80 | | | | | |
| | | | TKAN 100 | | | | | |
| | | | TKAN 150 | | | | | |
| | | | TKAN 200 | | | | | |
| | | | TKAN 250 | | | | | |

ELEKTRO KOMPONENTE I OSTALO TKAN 60 do TKAN 300

| No. | Slika dela / pictures of parts | DELOVI | Tip kotla / Type of boiler | Dimenzija / Dimesion | CODE PDM | CODE INFOerp | Q. | Težina / Weight (kg) | | | | |
|----------|---|--|----------------------------------|----------------------|----------|--------------|----|-------------------------|---|---|---|---|
| 1 |  | Grejač / Ignitoner | TKAN 60 | Vimoso 300W | K0001193 | 00010511 | 1 | | | | | |
| | | | TKAN 80 | | | | | | | | | |
| | | | TKAN 100 | / | / | / | / | / | | | | |
| | | | TKAN 150 | / | / | / | / | / | | | | |
| | | | TKAN 200 | / | / | / | / | / | | | | |
| | | | TKAN 250 | / | / | / | / | / | | | | |
| 2 |  | Fen igniter 230v - 1600w | TKAN 60 | / | / | / | / | / | | | | |
| | | | TKAN 80 | | | | | | | | | |
| | | | TKAN 100 | | | | | | | | | |
| | | | TKAN 150 | / | K0000360 | | 1 | 6,30 | | | | |
| | | | TKAN 200 | / | | | | | | | | |
| | | | TKAN 250 | / | | | | | | | | |
| 3 |  | Automatika (TIEMMA) kompletna / Complete CONTROL (TIEMME) | TKAN 60 | / | K0000408 | 00011792 | 1 | | | | | |
| | | | TKAN 80 | | | | | | | | | |
| | | | TKAN 100 | | | | | | | | | |
| | | | TKAN 150 | / | | | | | | | | |
| | | | TKAN 200 | / | | | | | | | | |
| | | | TKAN 250 | / | | | | | | | | |
| 4 |  | 7-polni konektor muški / 7-pole connector attach | TKAN 60 | / | K0000277 | 00008279 | 3 | | | | | |
| | | | TKAN 80 | | | | 2 | | | | | |
| | | | TKAN 100 | | | | | | | | | |
| | | | TKAN 150 | / | | | 1 | / | | | | |
| | | | TKAN 200 | / | | | | | | | | |
| | | | TKAN 250 | / | | | | | | | | |
| 5 |  | 7-polni konektor ženski / 7-pole connector | TKAN 60 | / | K0000540 | 00008268 | 3 | | | | | |
| | | | TKAN 80 | | | | 2 | | | | | |
| | | | TKAN 100 | | | | | | | | | |
| | | | TKAN 150 | / | | | 1 | / | | | | |
| | | | TKAN 200 | / | | | | | | | | |
| | | | TKAN 250 | / | | | | | | | | |
| 6 |  | 3-polni konektor muški / 3-pole connector attach | TKAN 60 | / | K0000278 | 00009448 | 1 | | | | | |
| | | | TKAN 80 | | | | 4 | | | | | |
| | | | TKAN 100 | | | | 9 | | | | | |
| | | | TKAN 150 | / | | | | / | | | | |
| | | | TKAN 200 | / | | | 4 | | | | | |
| | | | TKAN 250 | / | | | | | | | | |
| 7 |  | 3-polni konektor ženski / 3-pole connector | TKAN 60 | / | K0001090 | 00009449 | 1 | | | | | |
| | | | TKAN 80 | | | | 4 | | | | | |
| | | | TKAN 100 | | | | 9 | | | | | |
| | | | TKAN 150 | / | | | | / | | | | |
| | | | TKAN 200 | / | | | 4 | | | | | |
| | | | TKAN 250 | / | | | | | | | | |
| 8 |  | Sonda dimovodnih gasova / Flue gas probe | TKAN 60 | L = 2500 mm | K0001362 | | 1 | / | | | | |
| | | | TKAN 80 | | | | | | | | | |
| | | | TKAN 100 | | | | | | | | | |
| | | | TKAN 150 | L=4000 mm | K0001363 | | | | | | | |
| | | | TKAN 200 | | | | | | | | | |
| | | | TKAN 250 | | | | | | | | | |
| 9 |  | Flex.rebrasto crevo Ø8 / Flexible ribbed pipe Ø8 | TKAN 60 | L = 4100 mm | K0001084 | | 1 | / | | | | |
| | | | TKAN 80 | L=17100 mm | | | | | | | | |
| | | | TKAN 100 | L=26500 mm | | | | | | | | |
| | | | TKAN 150 | L=13900 mm | | | | | | | | |
| | | | TKAN 200 | L=23900 mm | | | | | | | | |
| | | | TKAN 250 | L=24400 mm | | | | | | | | |
| 10 |  | Flex.rebrasto crevo Ø10 / Flexible ribbed pipe Ø10 | TKAN 60 | L = 2500 mm | K0001186 | | 1 | / | | | | |
| | | | TKAN 80 | L=5700 mm | | | | | | | | |
| | | | TKAN 100 | L=1600 mm | | | | | | | | |
| | | | TKAN 150 | L=7200 mm | | | | | | | | |
| | | | TKAN 200 | / | | | | | / | / | / | / |
| | | | TKAN 250 | / | | | | | / | / | / | / |
| TKAN 300 | / | / | / | / | / | | | | | | | |

| | | | | | | | | | |
|----------|---|--|----------|---------|----------|---|---|---|-----------|
| 11 |  | Flex.rebrasto crevo Ø12 / Flexible ribbed pipe Ø12 | TKAN 60 | / | / | / | / | / | |
| | | | TKAN 80 | | | | | | |
| | | | TKAN 100 | | | | | | |
| | | | TKAN 150 | | | | | | L=3500 mm |
| | | | TKAN 200 | | | | | | L=2600 mm |
| TKAN 250 | L=2800 mm | | | | | | | | |
| 12 |  | Flex.rebrasto crevo Ø28 / Flexible ribbed pipe Ø28 | TKAN 300 | / | / | / | / | / | |
| | | | TKAN 60 | | | | | | L=1500 mm |
| | | | TKAN 80 | | | | | | L=500 mm |
| | | | TKAN 100 | | | | | | L=600 mm |
| | | | TKAN 150 | | | | | | L=500 mm |
| | | | TKAN 200 | | | | | | L=600 mm |
| | | | TKAN 250 | | | | | | L=600 mm |
| 13 |  | Šarka za vrata silosa / Hinge for silos | TKAN 300 | 60 x 90 | K0000279 | / | / | / | |
| | | | TKAN 60 | | | | | | |
| | | | TKAN 80 | | | | | | |
| | | | TKAN 100 | | | | | | |
| | | | TKAN 150 | | | | | | |
| | | | TKAN 200 | | | | | | |
| | | | TKAN 250 | | | | | | |